

# avocor



AVG Series  
User Manual

# TABLE OF CONTENTS

<b>Compliance Information</b> .....	<b>3</b>
<b>Declaration of Conformity</b> .....	<b>3</b>
<b>FCC Part 15</b> .....	<b>3</b>
<b>Caution</b> .....	<b>3</b>
<b>Industry Canada (ICES-003)</b> .....	<b>4</b>
<b>Product Disposal</b> .....	<b>4</b>
<b>Disposal of Old Electrical and Electronic Equipment</b> .....	<b>4</b>
<b>Introduction</b> .....	<b>5</b>
About This Manual.....	5
Textual Conventions .....	5
Graphic Conventions.....	6
<b>What's in the Box?</b> .....	<b>7</b>
<b>Specifications</b> .....	<b>8</b>
<b>The display, at a glance</b> .....	<b>9</b>
Front Panel.....	9
Back Panel.....	10
Front Panel Interface .....	11
PR Sensor .....	12
Rear Source Inputs.....	13
Bottom-Rear Panel Inputs.....	14
AC Power Inputs.....	15
Top-Rear & Side Panel Guest Inputs.....	16
<b>Installation</b> .....	<b>17</b>
Moving and Carrying Notice .....	18
Ambient Considerations .....	19
Ambient Light.....	19
Ambient Temperature .....	19
Ventilation .....	19
Mounting the Display.....	20

Wall Mount ..... 20

Peripheral Connections..... 22

    Top-Rear & Side Ports..... 22

    Rear-Side Ports..... 23

    Bottom-Rear Ports ..... 24

OPS Module ..... 25

    OPS Installation Step-by-Step ..... 25

Remote Control..... 28

    Remote Control Batteries ..... 29

**Operation ..... 31**

    The Home Screen..... 31

    The UiQ ..... 32

        Display Settings Tips ..... 34

        Network Settings Tips ..... 36

        Update System – Firmware..... 42

**External Control ..... 45**

    RS232 Connection and Port Configuration ..... 45

    TCP/IP Control Configuration..... 45

    Command and Response Format..... 45

    Serial Command List ..... 46

**Warranty Information ..... 51**

## COMPLIANCE INFORMATION

### Declaration of Conformity

Avocor hereby declares that the following Product Model Number:

#### AVG series

conforms to the provisions of the following regulations:

- FCC:
  - FCC CFR Title 47 Part 15 Subpart B Class A, CISPR22
  - ANSI C63.4
  - ICES-003
- CE:
  - EN 55032 / BS EN 55032
  - EN55024
  - EN 55035 / BS EN 55035
  - EN61000-3-2 / BS EN 61000-3-2
  - EN61000-3-3 / BS EN 61000-3-3Compliance with UKCA
- cTUVus:
  - UL 62368-1
  - CAN/CSA-C22.2 No. 62368-1
- CB:
  - IEC 62368-1
- CEC:
  - California Code of Regulations, Title 20: Division2, Chapter 4, Article 4, Selections 1601-1609

### FCC Part 15

This equipment has been tested and found to comply with the limits for a Class A digital device, pursuant to part 15 of the FCC Rules. These limits are designed to provide reasonable protection against harmful interference when the equipment is operated in a commercial environment. This equipment generates, uses, and can radiate radio frequency energy and may cause harmful interference to radio communications if not installed and used in accordance with the instruction manual. Operation of this equipment in a residential area is likely to cause harmful interference in which case the user will be required to correct the interference at her/his own expense.

### CAUTION

Any changes or modifications not expressly approved by the grantee of this device could void the user's authority to operate the equipment.

## Industry Canada (ICES-003)

CAN ICES-3 (A)/NMB-3(A)

### Product Disposal

The Product contains small amounts of tin, lead, and/or mercury. Disposal of these materials may be regulated due to environmental considerations.

### Disposal of Old Electrical and Electronic Equipment

**Applicable throughout the European Union and other European countries with separate collection programs**



This symbol, found on your product or on its packaging, indicates that this product should not be treated as household waste when you wish to dispose of it. Instead, it should be handed over to an applicable collection point for the recycling of electrical and electronic equipment. By ensuring that this product is disposed of correctly, you will help prevent potential negative consequences to the environment and human health, which could otherwise be caused by inappropriate disposal of this product.

The recycling of materials will help to conserve natural resources. This symbol is only valid in the European Union. If you wish to discard this product, please contact your local authorities or dealer and ask for the correct method of disposal.

## INTRODUCTION

Your new Avocor AVG series display is an ultra-high definition interactive touch display supporting full range 4K@60hz resolution, up to 20 simultaneous touch points, multiple source inputs for your computers and peripheral devices, and our new intuitive **UiQ**.

Our AVG series displays follow our agnostic approach to interactive displays: they are compatible with a wide range of hardware and software, making it a great addition to any interactive meeting-room solution.

Whether you need a virtual meeting space for your conference room, or a powerfully adaptive whiteboard or presentation hub for your classroom, the Avocor AVG series will exceed your expectations.

## About This Manual

This user manual was written to help you get the most out of your display.

In addition to detailed descriptions of the display and its features, this manual will guide you through the installation and setup processes and provide tips, tricks, and best practices on how best to utilize the display.

We make every effort to ensure that this manual is accurate as of the date it was printed. However, it may require periodic updating due to ongoing product improvements and customer feedback. Find the latest version of our manuals at [Avocor.com](http://Avocor.com).

## Textual Conventions

The following textual conventions are used in this manual to denote certain actions or information for clarification purposes. Here are the details:

- Remote control and display keypad controls are set in CAPS. For example, "Press OK on the remote control to accept your changes."
- Menus in the OSD and computer interface are in **bold**. The ">" symbol is used to help denote submenu navigation. For example, "Open **Display > Picture > Advanced Settings** to adjust various picture settings."
- Keyboard keys with functional names are capitalized and set in <Angle Brackets>. For example, "press <Enter> to make your selection."
- In addition to the above, underlining, *italics*, or a combination of the two are used periodically to help emphasize key points in the text of this manual.

## Graphic Conventions

The following symbols appear throughout this manual to emphasize key points. Keep these in mind not only to benefit from their advice, but also to avoid problems with the display or personal injury.



TIP

Highlights helpful guidelines and best practices for using certain features.



NOTE

Provides supplemental information and emphasize text of special significance.



CAUTION

Alerts that given actions may degrade the performance of the display or cause a malfunction.



WARNING

Alert that a given action may result in damage to equipment or personal injury.



DANGER

Alert that a given action may cause serious personal injury or death.

## WHAT'S IN THE BOX?

- Avocor AVG series Interactive Display
- Quick Start Guide and User Manual QR code
- Remote Control & Batteries
- (2) Touch Stylus
- Power Cables
  - US Cable 1.8m
  - UK Cable 1.8m
  - European Cable 1.8m
  - AUS Cable 1.8m
- (1) HDMI cable 3m
- (1) USB-B cable 3m
- (1) USB-C cable 1.8m
- (5) Cable Clips



## SPECIFICATIONS

Model	AVG-6560	AVG-7560	AVG-8560
<b>LCD Panel</b>			
Diagonal Size (Inches)	65	75	85
Backlight	Direct-lit LED		
Aspect Ratio	16:9		
Resolution	3840 x 2160 @ 60Hz		
Response Time	9.5 ms		
Brightness	400 (cd/m <sup>2</sup> )	400 (cd/m <sup>2</sup> )	400 (cd/m <sup>2</sup> )
Contrast Ratio	5000:1	5000:1	5000:1
Viewing Angle	178°/178°		
Supported Colors	1.07 Billion Colors		
Display Orientation	Landscape		
<b>Touch System</b>			
Touch	Up to 20 Point Avocor Intelligent Touch – Supports 4 fine tip stylus		
Glass	3.2 mm AG & AF Coating Tempered Glass		
Supported OS	Windows 7 Pro, 8, 8.1 & 10; Mac OS 10.1 or later; Linux based OS Kernel 3.15 or later		
<b>Connectivity</b>			
Rear Inputs	2x USB 3.0, 1x Type-C, 1x DisplayPort 1.2, 2x HDMI 2.0, 3x USB-B Touch 3.0		
Other Inputs	3x HUB USB 3.0, 1x USB Service Port 2.0, 1x HDMI Out		
Audio	1x Audio Out, 1x SPDIF Out		
Control	1x IR in, 1x LAN Ethernet in, 1x LAN Ethernet out, 1x RS232C		
OPS Slot	Yes, 3840 x 2160 @ 60Hz		
<b>Audio</b>			
Built-in Speakers	2x 15W		
MIC Array	4 Microphones, operating distance up to 5m		
<b>Sensors</b>			
IR Sensor	3 ± 0.5m		
PR Sensor	3.5 ± 0.5m		
<b>Display Functions</b>			
Auto-source detection, Source Preview			
<b>Physical Specifications</b>			
Product Dimensions	1481.4 x 884.4 x 116mm 58.3 x 34.8 x 4.6 in	1703.5 x 1009.2 x 116.8 mm 67.1 x 39.7 x 4.6 in	1929.5 x 1138.5 x 117.2 mm 76 x 44.8 x 4.6 in
Weight	Net: 56 kg / 123.4 lbs Gross: 75.5 kg / 166.5 lbs	Net: 71.6 kg / 157.9 lbs Gross: 100 kg / 220.5 lbs	Net: 91.3 kg / 201.3 lbs Gross: 124 kg / 273.4 lbs
Wall Mount (VESA)	400 x 400 mm	600 x 400 mm	600 x 400 mm
Mini PC Mount	100 x 100 mm		
Handles (Removable)	4		
<b>Power</b>			
Power Supply	AC100 – 240V (Worldwide)		
	Max 5.0A, 50/60Hz	Max 6.2A, 50/60Hz	Max 7.2A, 50/60Hz
Max Power Consumption	335W (Non-OPS)	395W (Non-OPS)	480W (Non-OPS)
Standby	≤0.5W		
<b>Environmental</b>			
Operating Temperature	0°C ~ 40°C / 32° F ~ 104° F		
Storage Temperature	-20° C ~ 60° C / -4° F ~ 140° F		
Humidity	35% ~ 85%		

## THE DISPLAY, AT A GLANCE

The following diagrams depict the front, side, and bottom panels of the display. The physical interface and connections are labeled, and then described in the tables that follow.

### Front Panel



<b>1</b>	<b>Microphone Array</b>	4 microphones
<b>2</b>	<b>Front Panel Interface</b>	See Page 11 for more details.
<b>3</b>	<b>IR Sensor / Light Sensor</b>	See Page 11 for more details
<b>4</b>	<b>Pen Holder</b>	Magnetized pen storage.
<b>5</b>	<b>PR Sensor</b>	See Page 12 for more details

### Back Panel

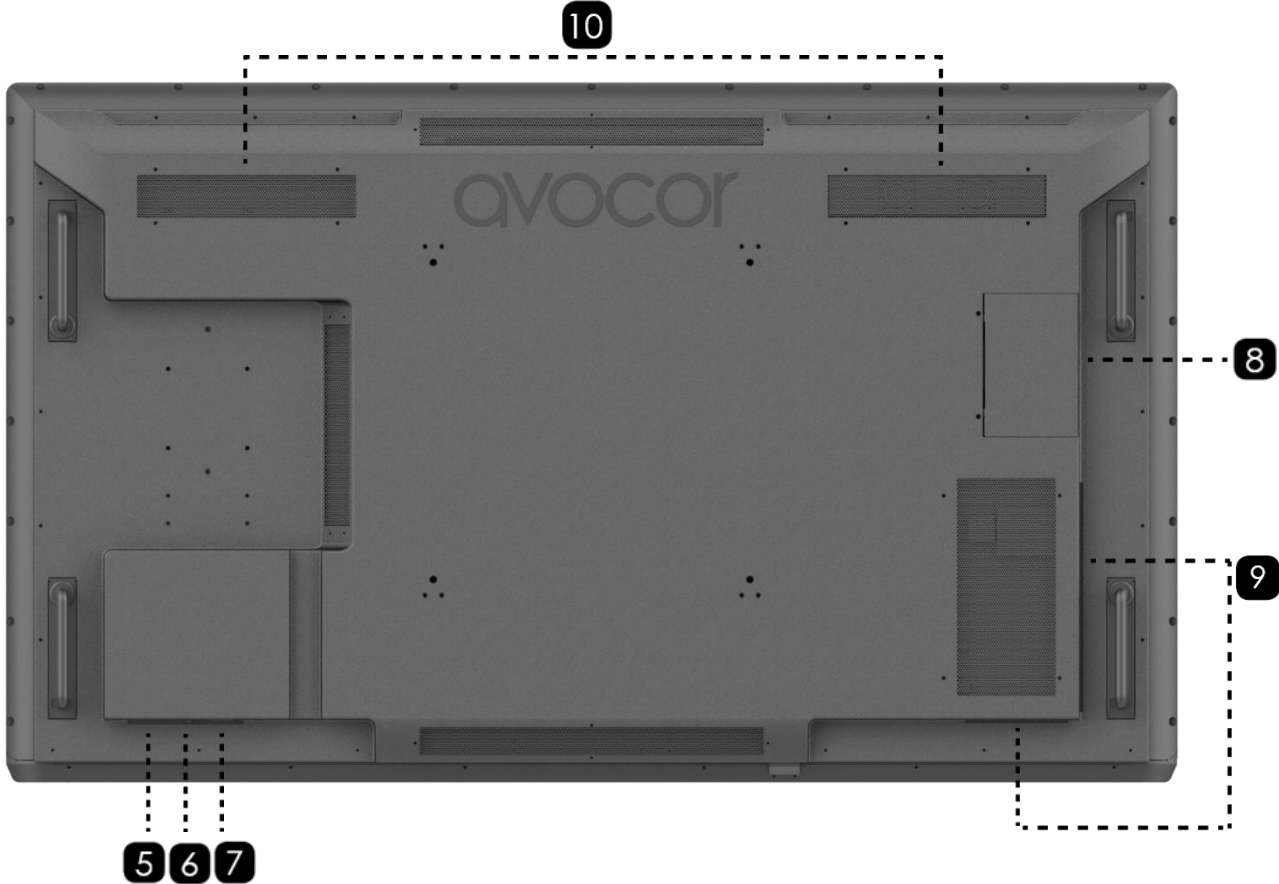

<b>5</b>	<b>AC Output</b>	IEC C14 type
<b>6</b>	<b>Main Power Switch</b>	A/C Rocker Switch; toggles all power to the display.
<b>7</b>	<b>AC Input</b>	IEC C14 type
<b>8</b>	<b>OPS Slot</b>	80 Pin JAE TX24A-80R standard OPS input
<b>9</b>	<b>Rear Source Inputs</b>	DisplayPort, HDMI 1, HDMI 2, Touch USB 3.0, USB 3.0, Type-C, Audio Out, IR, SPDIF Out, HDMI Out.
<b>10</b>	<b>Speakers</b>	2 X 15W; 12V

## Front Panel Interface

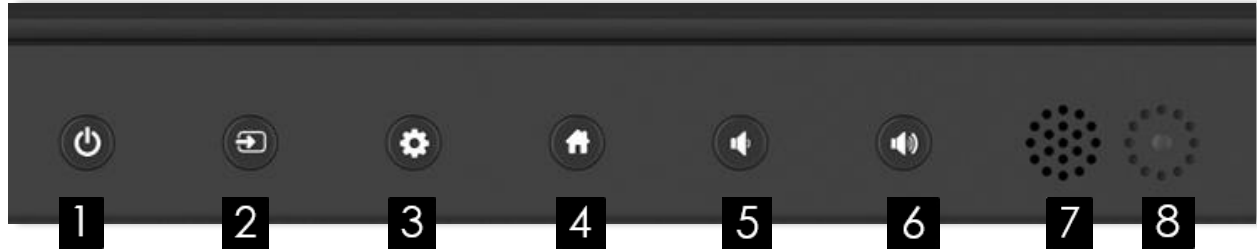

<b>1</b>	<b>Power</b>	Turn the display on/off.
<b>2</b>	<b>Source</b>	Switch sources.
<b>3</b>	<b>Menu</b>	Open <i>UiQ Settings</i> .
<b>4</b>	<b>Home</b>	Access the <i>Home</i> screen.
<b>5</b>	<b>Volume -</b>	Short press to reduce one level of volume; Long press, continue to reduce the volume.
<b>6</b>	<b>Volume +</b>	Short press to increase the volume; Long press, continue to increase the volume.
<b>7</b>	<b>IR sensor</b>	Receives the remote control's commands to control the display.
<b>8</b>	<b>Light sensor</b>	Supports the light detection when <b>Backlight's Auto feature is enabled</b> , see more details in <i>UIQ</i> settings – <b>Display &gt; Picture &gt; Backlight</b> .

PR SENSOR

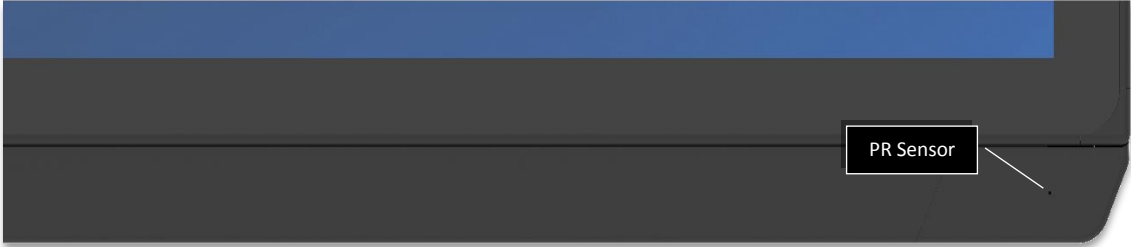

<b>PR Sensor</b>	Detects movement in a scanned area, for angle coverage and detection range, see the image below:
------------------	--



Sensing Angle: 120 degrees  
Sensing Distance: 3.5 ± 0.5 meters

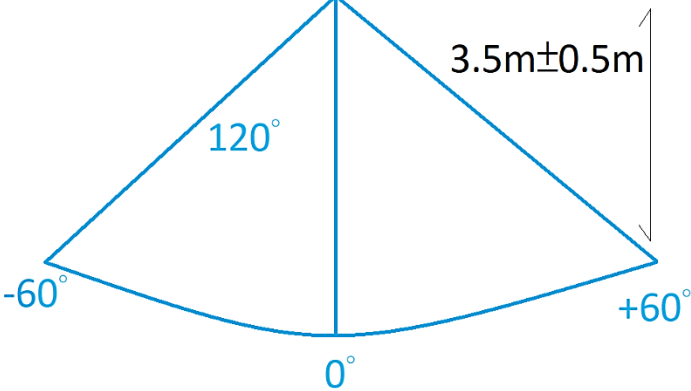

## Rear Source Inputs

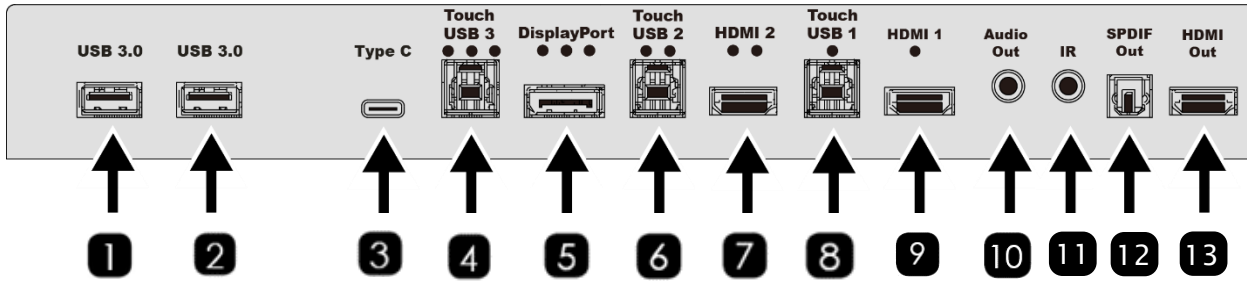

<b>1</b>	<b>USB 3.0</b>	USB 3.0 type A for connecting external media, keyboard, or mouse.
<b>2</b>	<b>USB 3.0</b>	USB 3.0 type A for connecting external media, keyboard, or mouse.
<b>3</b>	<b>Type-C</b>	USB Type-C for connecting DP, USB, Power Delivery and Ethernet.
<b>4</b>	<b>Touch USB 3</b>	USB 3.0 Type B for touch control.
<b>5</b>	<b>DP</b>	DP1.2 & HDCP2.2.
<b>6</b>	<b>Touch USB 2</b>	USB 3.0 Type B for touch control.
<b>7</b>	<b>HDMI2</b>	HDMI2.0 & HDCP2.2.
<b>8</b>	<b>Touch USB 1</b>	USB 3.0 Type B for touch control.
<b>9</b>	<b>HDMI1</b>	HDMI2.0 & HDCP2.2.
<b>10</b>	<b>Audio Out</b>	Connects external, powered speakers or audio receiver.
<b>11</b>	<b>IR</b>	Connects an IR Extender cable
<b>12</b>	<b>SPDIF Out</b>	Connects external and powered digital speakers or audio receiver.
<b>13</b>	<b>HDMI Out</b>	HDCP compliant HDMI out.

### Bottom-Rear Panel Inputs

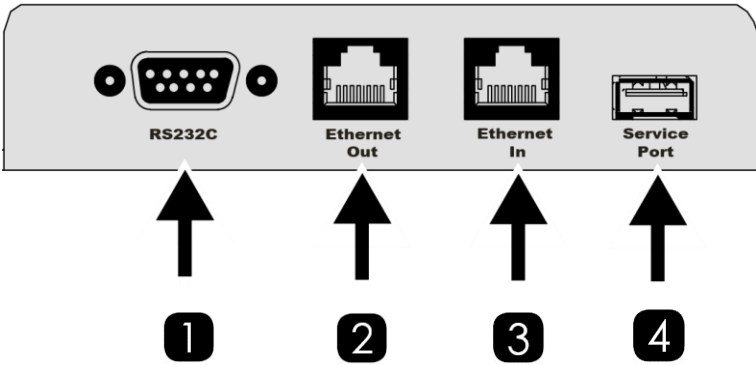

<b>1</b>	<b>RS232C</b>	DB9 Female Input	For interfacing with a PC or automation/control system.
<b>2</b>	<b>Ethernet Out</b>	RJ45 Output	Lan Out, 10/100Mbps.
<b>3</b>	<b>Ethernet In</b>	RJ45 Input	Lan In, 10/100Mbps.
<b>4</b>	<b>Service Port</b>	USB Type A Connector	Connect a USB stick for firmware upgrade.

# AC Power Inputs

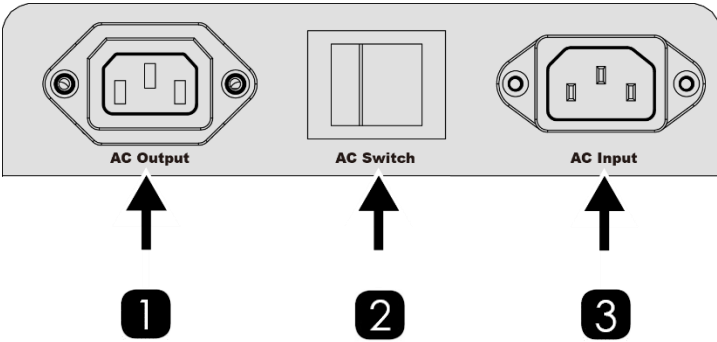

<b>1</b>	<b>AC Output</b>	A power output connection.
<b>2</b>	<b>AC Switch</b>	Turn the AC power on / off.
<b>3</b>	<b>AC Input</b>	A power input connection



# Top-Rear & Side Panel Guest Inputs

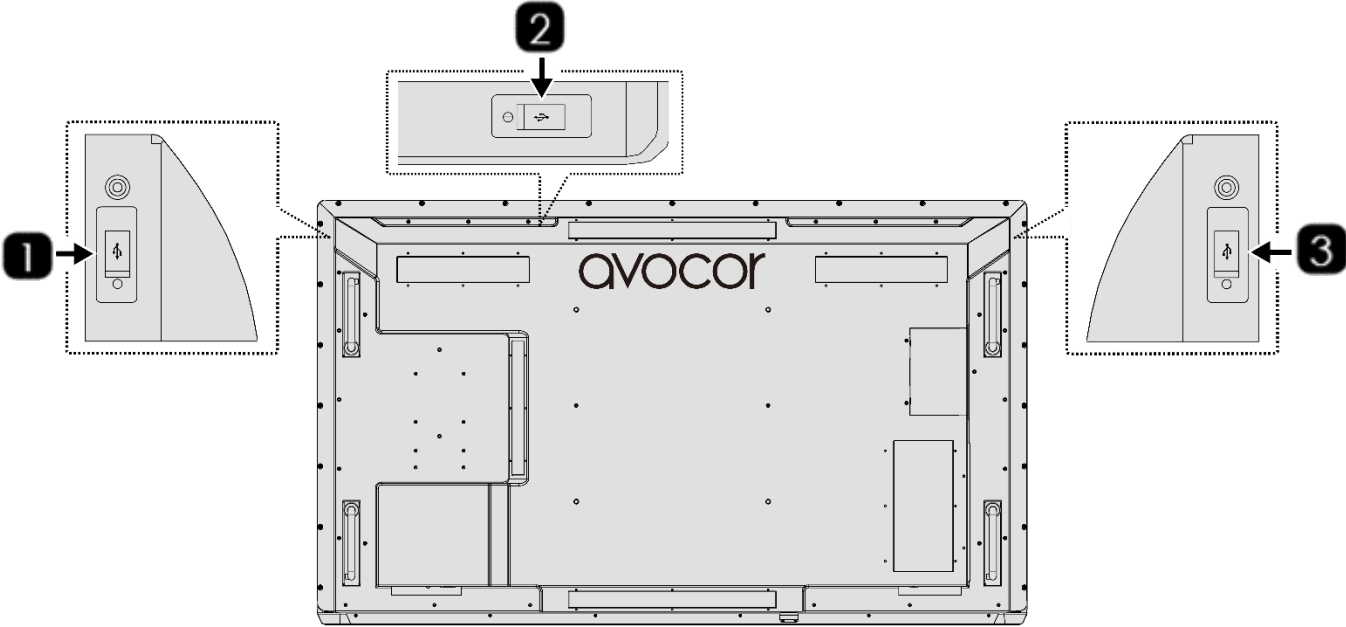

<b>1</b>	<b>USB 3.0</b>	USB 3.0 type A for connecting external media, keyboard, or mouse.
<b>2</b>	<b>USB 3.0</b>	USB 3.0 type A for connecting external media, keyboard, or mouse.
<b>3</b>	<b>USB 3.0</b>	USB 3.0 type A for connecting external media, keyboard, or mouse.

## INSTALLATION

 Please read the following precautions carefully before installing your new Avocor AVG series display. Failure to comply may result in damage to the display and equipment and may result in personal injury or death.

- DO NOT install the display in a high temperature environment or near any apparatus that produce heat.
  - This may cause damage to the panel and equipment. It may also cause personal injury due to electrical shock resulting from overheating.
- DO NOT install the display in a high humidity environment or an environment where it can come into contact with water.
  - This may cause damage to the panel and equipment. It may also cause personal injury due to electrical shock resulting from overheating.
- DO NOT overload outlets or cables beyond their electrical capacity.
- DO NOT insert the power plug into an outlet rated outside the range of 100~240V A/C.
- DO NOT insert the power plug into a damaged outlet.
- DO NOT use a worn or damaged A/C power cable.
- DO NOT use an improper or mismatched A/C power cable.
- DO NOT place the display on an unstable shelf or surface.
- DO NOT place objects on the display as instructed below:
  - Do not cover the vents on the display.
  - Do not allow liquid or small particles to enter the vents or other parts of the display.
  - Do not put heavy objects on the display.
- Please allow room between the wall and the display panel to maintain proper ventilation and avoid overheating.
- Make sure you use the handles on the back of the display while lifting or moving the display, to avoid touching the front panel during the move.
- When unpacking, and carrying the display please follow these guidelines:
  - 2 people are needed for displays up to 65"
  - 3 people are needed for displays up to 75"
  - 4 people are needed for displays up to 85"
- Before installing, please make sure the wall is strong enough to hold the necessary weight of the display and the mount.

# Moving and Carrying Notice

- To avoid possible damage to the display like bending of parts, make sure to spread the load evenly for vertical lifting.

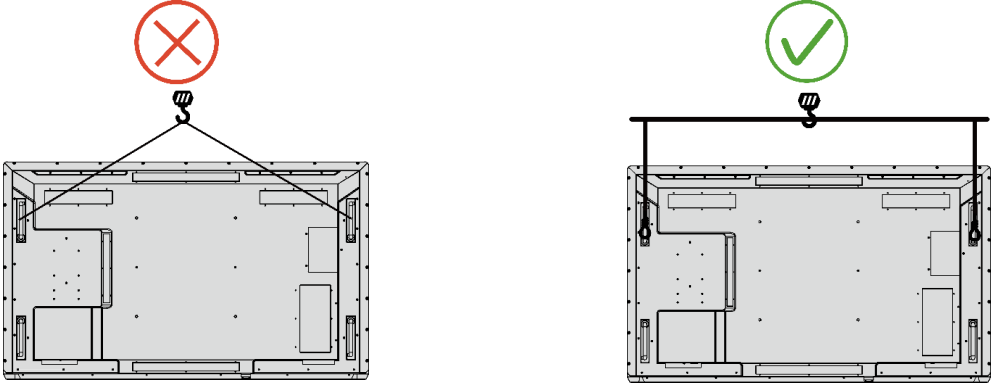

- The handles are designed for manual lifting only. Please do not use improper tools or equipment to carry the display which will cause damage to the handles.

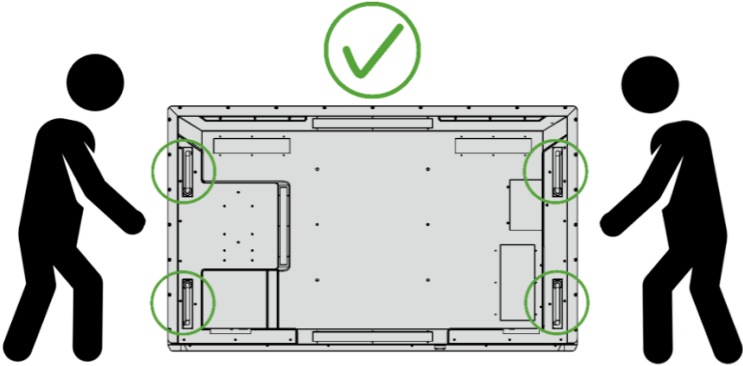

- Do not lean the left, right or top side of the display against a hard surface or the floor during the transporting, it will cause defects or cracks.

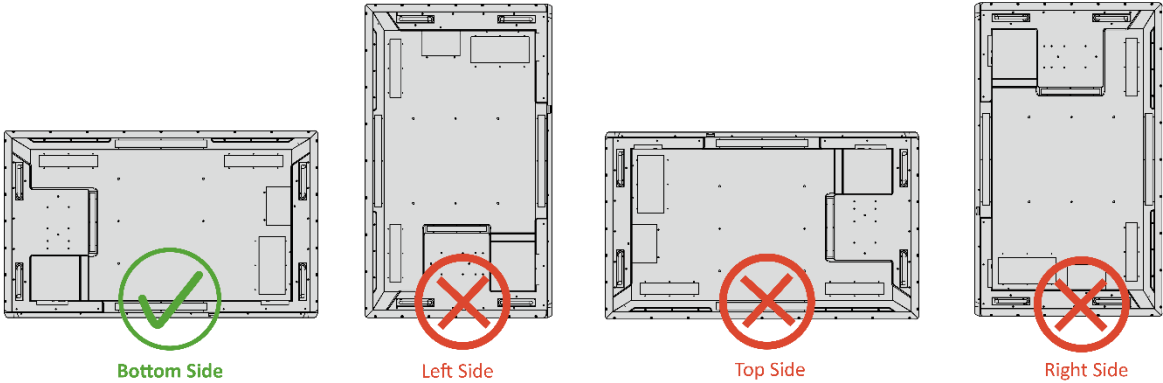

**ONLY THE "BOTTOM SIDE" CAN LEAN ON THE FLOOR SOFTLY**

## Ambient Considerations

Environmental and ambient factors play a considerable role in determining your viewing experience and the functional operation of the display. Make sure to follow these guidelines carefully to get the most out of your display.

### AMBIENT LIGHT

For the best viewing experience, make sure to minimize or remove light sources directed at the screen, especially sunlight.

Any direct light may make images on the screen appear washed out and less vibrant, and direct sunlight may even affect touch control operation.

### AMBIENT TEMPERATURE

Maintain the ambient temperature of the room at a consistent level. This will ensure that the display continues to operate smoothly.

Do not place the display near heat sources or air conditioning vents, and do not operate or store the display in temperatures above 40 degrees Celsius (104 degrees Fahrenheit).

### VENTILATION

The display should maintain a proper operating temperature provided that the ambient temperature is not too high, and that the vents on the display have enough room to disperse any heat emanating from the display.

**⚠** Do not block the vents on the display! Leave a space of about 4 inches between all sides of the display and surrounding walls or objects, as shown in the figure, below.

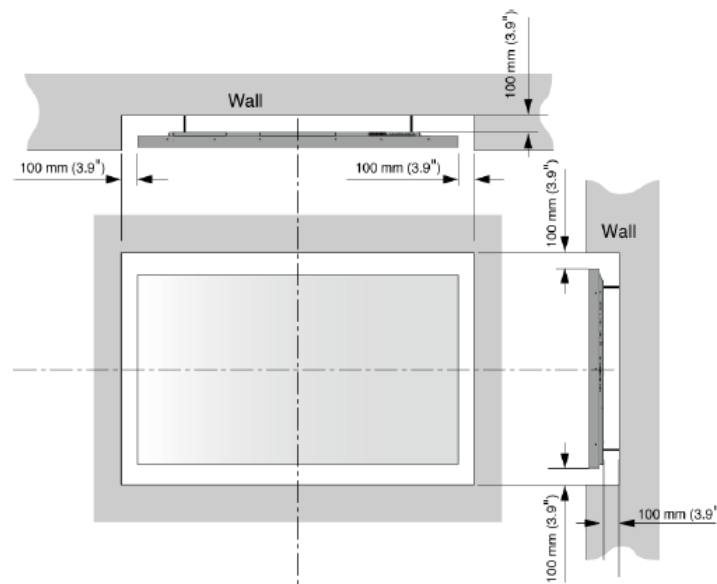

## Mounting the Display

You can mount the display on a wall. If you do decide to wall-mount the display, ensure that the wall-mount bracket is installed according to the instructions included with it. The wall must be capable of supporting a redundant weight factor three (3) times the weight of the display, or be reinforced.



### NOTE

- Leave mounting to the installation specialists.
- Always make sure that your stand, or mount/wall is rated to hold the weight of your display.
- Make sure that the surface you place the mount or stand upon can support the weight of your display.
- Make sure the tilt degree of the display does not exceed 2°.
- Always get help when moving or mounting the display.
  - 2 people are needed for displays up to 65"
  - 3 people are needed for displays up to 75"
  - 4 people are needed for displays up to 85"

### WALL MOUNT

Follow the manual instructions for the type of mount you have selected. Refer all servicing to qualified service personnel.

Moving the display requires at least two people. Make sure you use the handles in the back of the display while lifting or moving the display, to avoid touching the front panel during the move.

Before installing, please make sure the wall is strong enough to hold the necessary weight of the display and the mount.

**Step1.** Keep the display facing the ground and place it on a flat object.

**Step2.** Remove the screws (M8\*15) from the back of the display.

**Step3.** Align the wall brackets with the mounting holes and attach the brackets to the display using the screws removed in Step 2.



Longer screws will damage the display.

### VESA Mount Dimensions:

- AVG-6560 : 400 x 400mm
- AVG-7560 / AVG-8560 : 600 x 400mm

Use maximum 15mm/0.59" long screws. 8mm/0.3" Metric

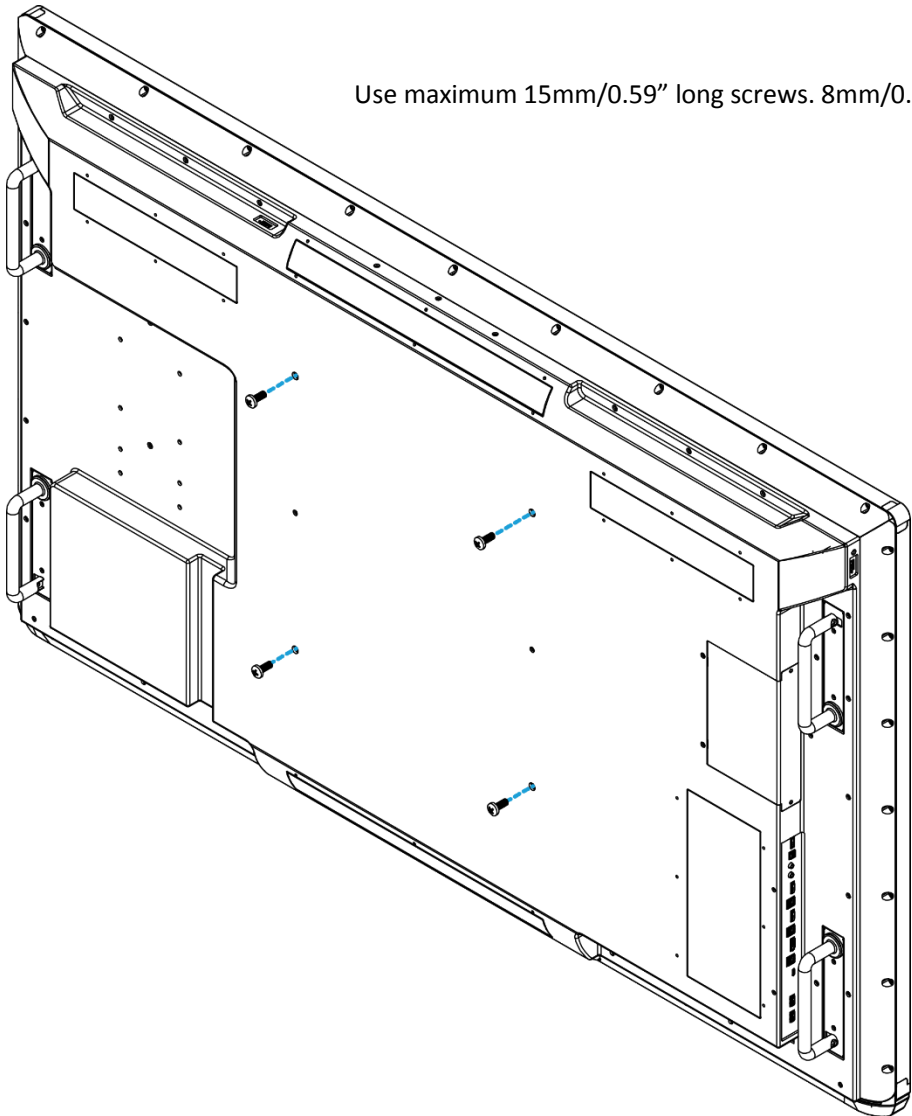

**NOTE**

- Use only the approved wall-mount kit designed for the display; talk to the installation experts for their recommendations and advice.
- Make sure the tilt degree of the wall does not exceed 2 degrees.

Rear Tilt

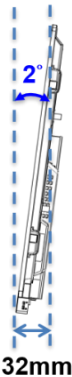

Forward Tilt



## Peripheral Connections

Your Avocor AVG series display supports connections to multiple peripheral devices, from computers, to wireless presentation systems, to external control systems.

The below diagrams demonstrate how to connect your peripherals for the best possible results.

### TOP-REAR & SIDE PORTS

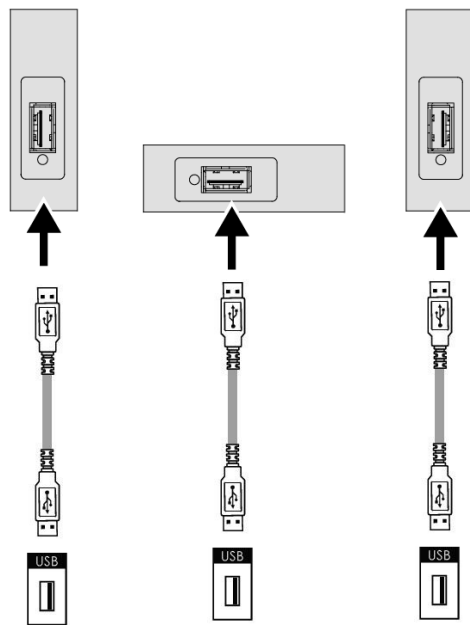

This is where you can connect your AVG series with an external media device, a keyboard, a mouse or an accompanying USB 3.0 compatible accessory.

REAR-SIDE PORTS

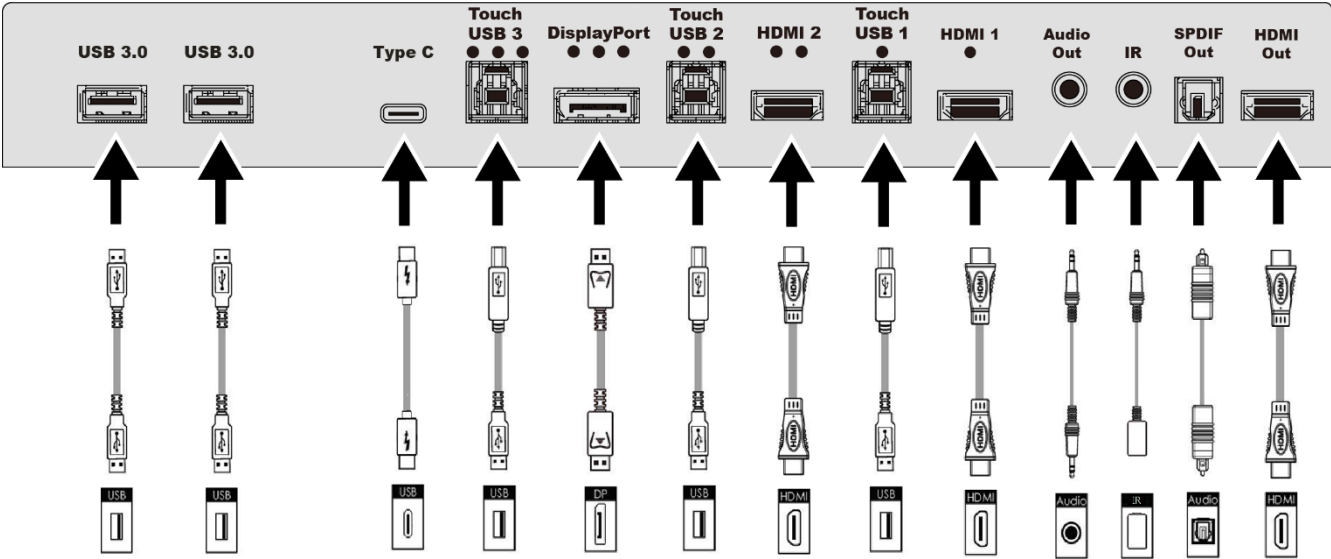

The preferred method to properly connect a device to the panel is to connect your device to one of the video inputs via HDMI or DisplayPort and connect your USB-A—USB-B cable to your device and the USB Touch input. The Type-C port will support both touch and video. If using the HDMI port for video, the USB Touch input is required to enable touch control.



BOTTOM-REAR PORTS

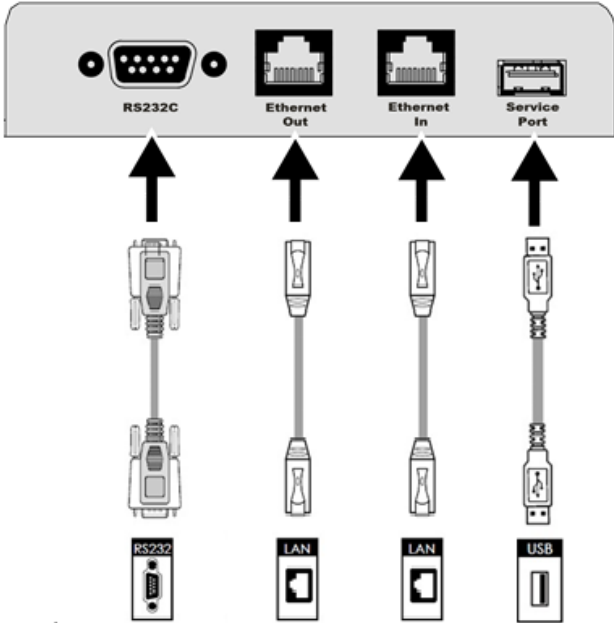

 The bottom rear ports on your AVG series display are great for connecting your network, control and update systems. **The Service Port is only intended for firmware updates and can only connect via a USB stick.**

## OPS Module

Your Avocor AVG series is compatible with any Open Pluggable Standard (OPS) computer module.



Installing an Avocor OPS module is a relatively simple process, but one that still needs a level of care and attention. Improper installation may cause malfunction or even damage the OPS module or the OPS Slot-Connector on the display. *Please follow these instructions carefully.*

### OPS INSTALLATION STEP-BY-STEP

- I. Turn off the main power switch for the AVG series display.
- II. **Remove the screw of the handle** on the display input panel

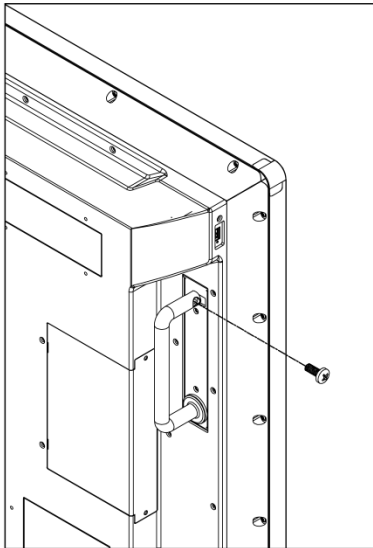

- III. **Turn the handle clockwise** direction gently

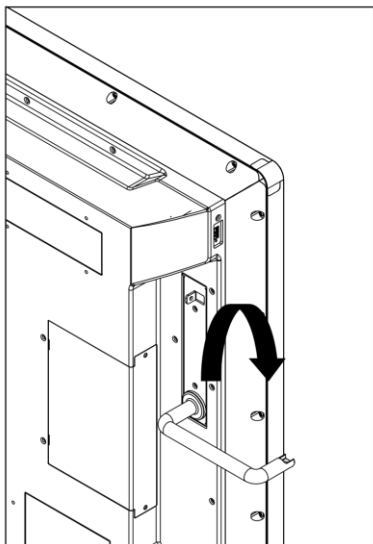

IV. Take off the handle carefully on the display input panel

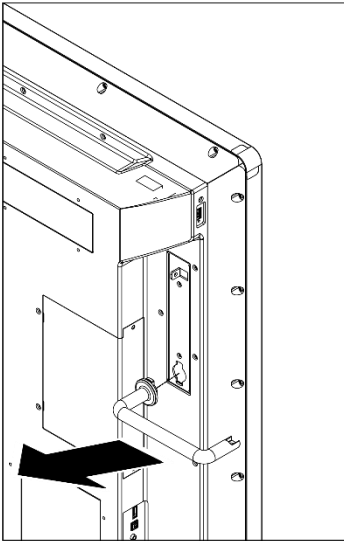

V. Remove the OPS slot shield on the display input panel

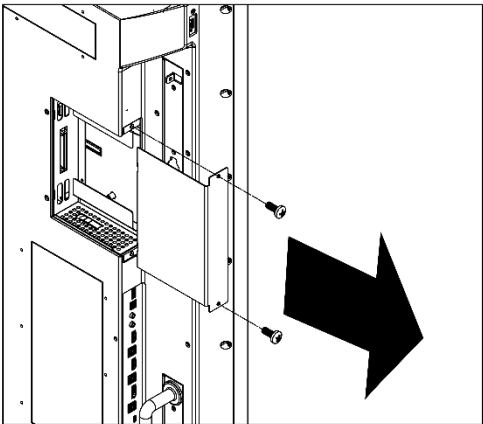

VI. Install the OPS computer by carefully sliding it into the OPS slot as pictured below.

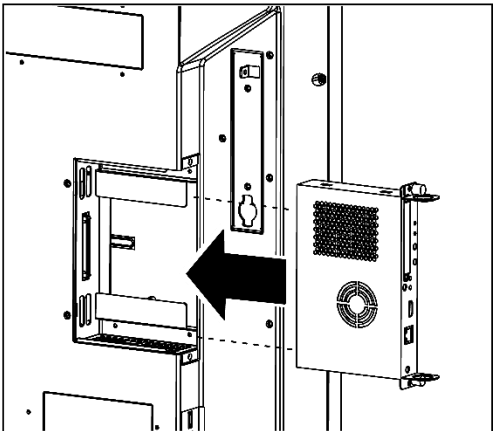



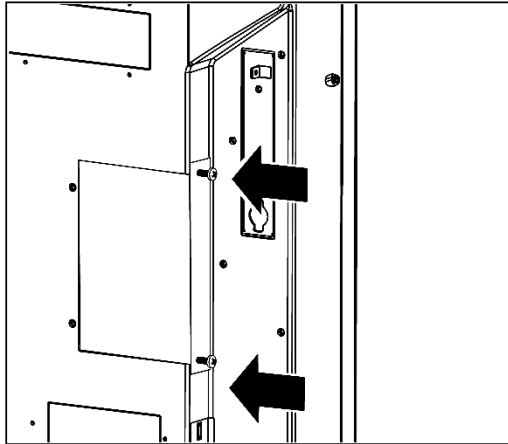





VII. **Secure the OPS computer into the slot** using the screws that were removed earlier



That's it! Your OPS should be ready to go. Turn the main power of the display back on and hit the power button on the OPS module to begin operation.

## Remote Control



	POWER	Power on/off the display
	HOME	Navigate to the selected Favorite Source
	SOURCE	Open the source selection menu
	OK/ DIRECTION KEYS	Menu navigation and selection
	EXIT	Go back to the previous menu
	VOL. -	Lower the volume
	VOL. +	Increase the volume
	MENU	Open the OSD menu

## REMOTE CONTROL BATTERIES

To install batteries in the remote control:

1. Press down the tab on the cover plate and pull the cover plate up.
2. Insert the included batteries. Ensuring that the polarities correctly match the (+) and (-) markings inside the battery compartment.
3. Insert the lower tab of the cover into the opening and press down the cover until it clicks in place.



### Notes on Batteries

- Please only use approved AAA type batteries.
- Do not mix an old battery with a new one or different types of batteries.
- If you will not use the remote control for a long time, remove the batteries to avoid damage from battery leakage.
- Do not expose batteries to excessive heat such as from sunshine, fire or the like.
- Don't recharge, heat, disassemble, short or throw batteries into a fire.



### Notes on Remote Control Operation

- Make sure that there is nothing obstructing the infrared beam between the remote control and the IR receiver on the display.
- If the effective range of the remote-control decreases, or it stops working, replace the batteries with new ones.
- The remote control may fail to operate if the infrared remote sensor is exposed to bright sunlight or fluorescent lighting.
- Ambient conditions may possibly impede the operation of the remote control. If this happens, point the remote control at the display, and repeat the operation.



**Remote Control IR Sensor**

The effective area of the remote control includes the vertical distance within  $3 \pm 0.5$  metres in front of the display, and the area within an angle of 90 degrees from the vertical point to the left and the right.

**IR Remote Sensor Range:**  
Distance:  $3 \pm 0.5$  m  
Horizontal angle:  $90^\circ$

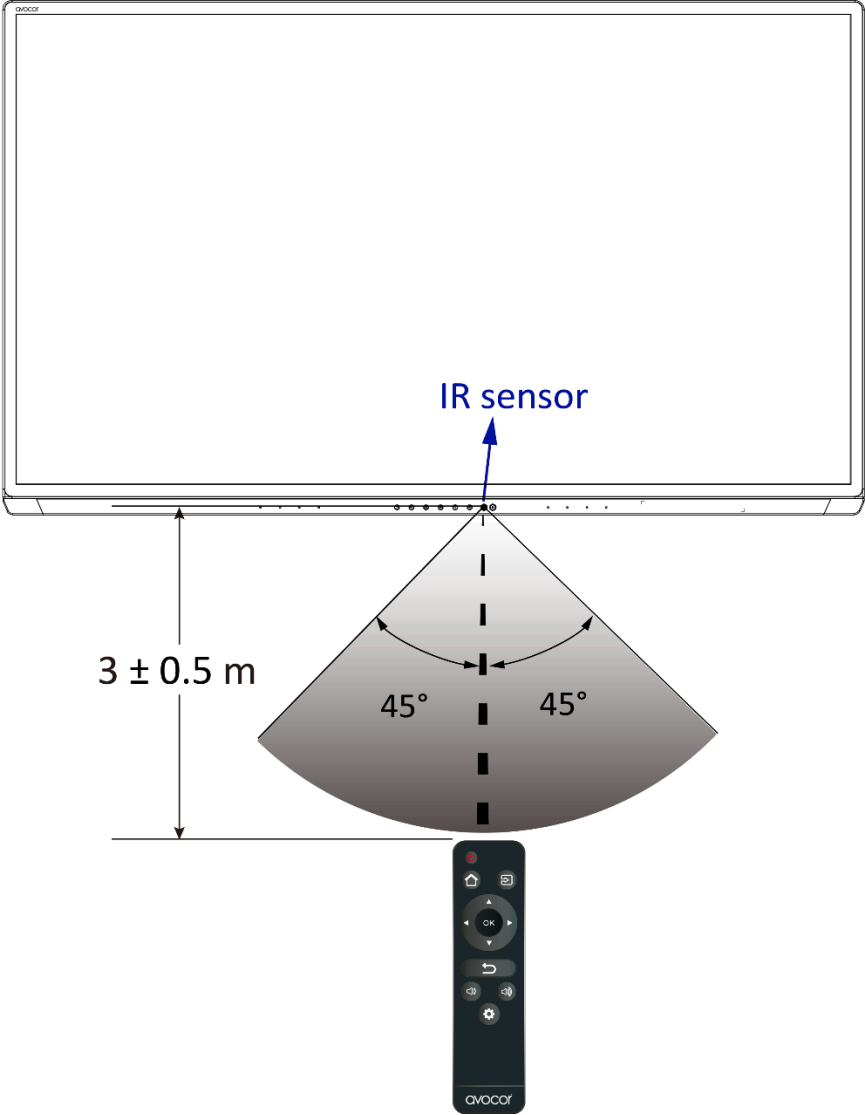

## OPERATION

The Avocor AVG series is our smart display featuring an intuitive touch interface for source navigation and OSD menu configuration. This chapter will provide information and best practices for operating the home-screen and the various on-screen display (OSD) menu settings to help facilitate the best possible user experience.

### Precaution

Please read the following precautions regarding normal operation carefully. Failure to follow the cautionary points therein may cause damage to the screen not covered by Avocor's warranty policy.

- If you encounter a problem during installation, please contact your dealer or Avocor support for assistance. **DO NOT** attempt to repair or open the display yourself.
- Always avoid placing the display flat face-down or face-up. **DO NOT** attempt to use the display lying flat on its back at any time.
- **DO NOT** set a static (non-moving) image on the display for an extended period of time, as this may cause image retention or "burn-in" which is not covered by warranty.
- **RECOMMENDED USAGE HOURS:**
  - Turn off the display for at least **8 hours** after every 16 hours of usage in a 24-hour period.

## The Home Screen

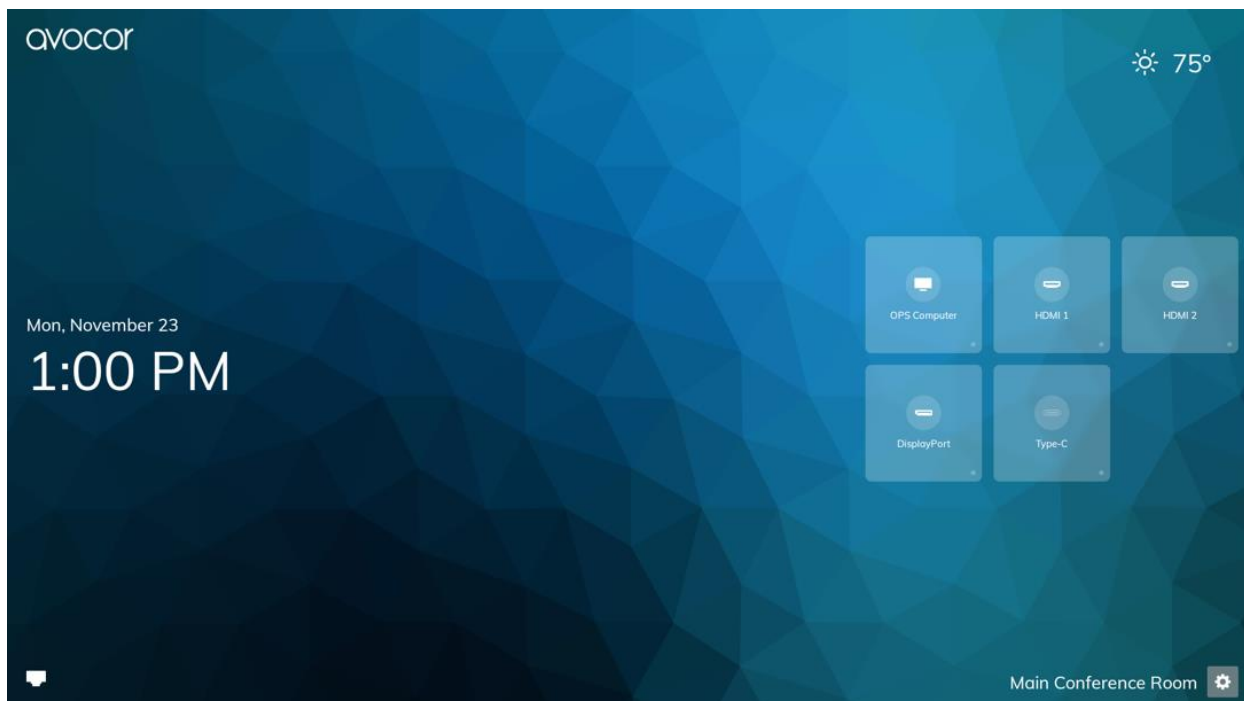



The Home Screen is the default landing page and general hub for the AVG series' touch interface. Here, you can configure the display's settings via the OSD and select an input source without having to use the remote control.



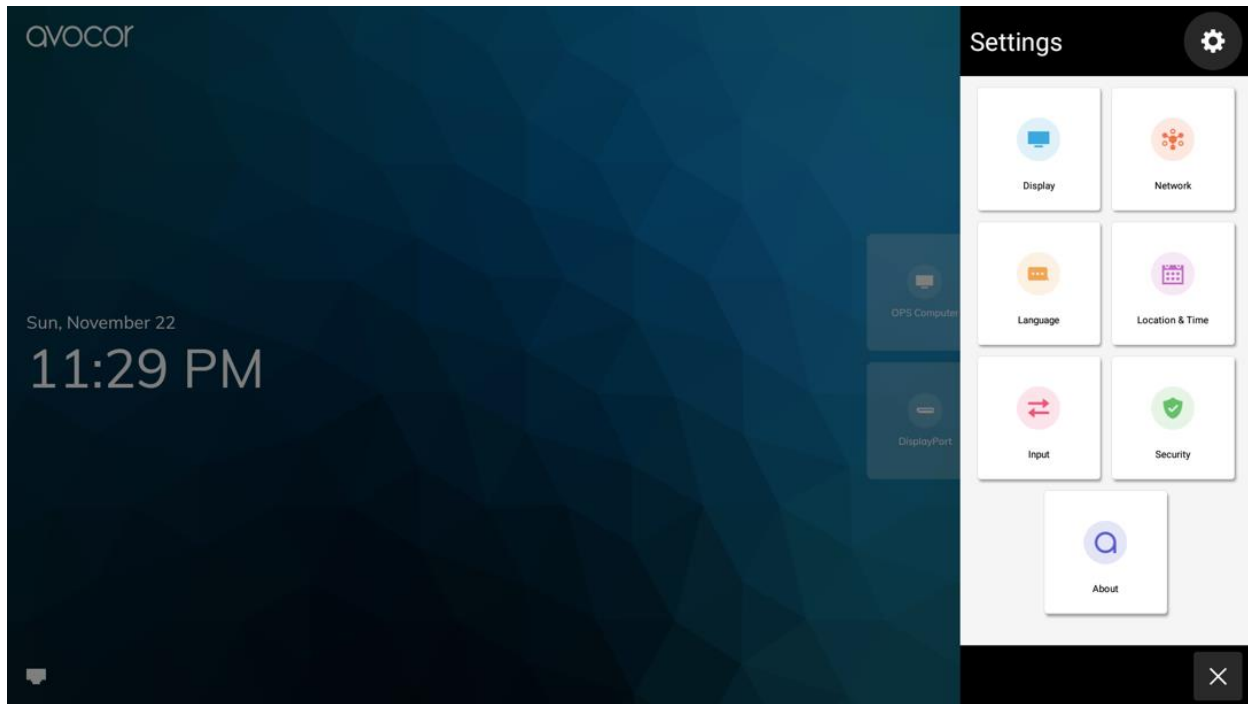

## The UiQ



To access the **UiQ**, touch the gear icon  on the home screen, or press the **Menu**  key on your remote control.

You can access the various menu settings by touching the icon squares in this interface (see the image above). Each menu will have a  button that will return to the previous menu.

Press the  button on the bottom right of the interface or touch the **Menu**  key on the remote control again to exit the OSD menu.

Read more information on each menu setting.

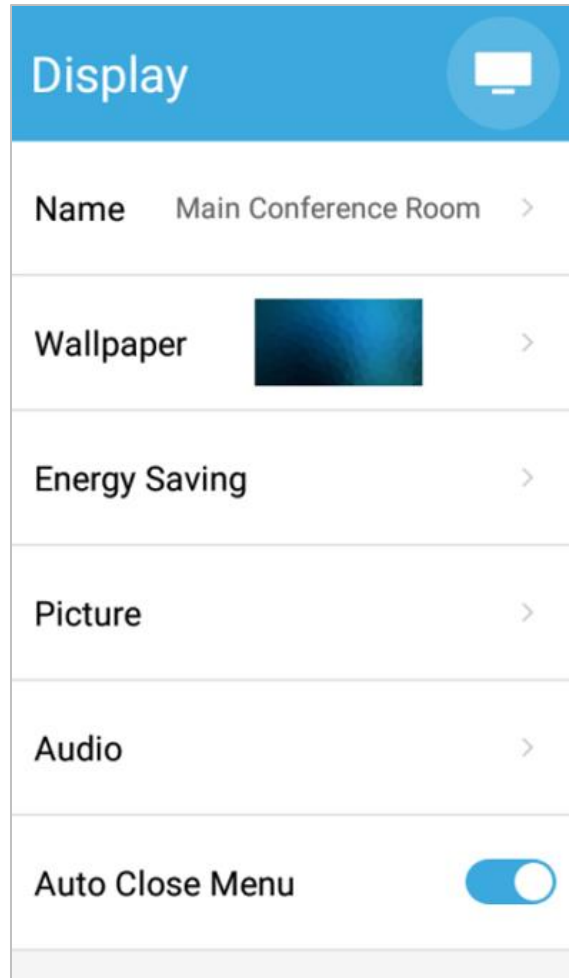

<b>Avocor Logo</b>	Toggles the presence of the Avocor logo on the Home Screen.
<b>Name</b>	Changes the name assigned to the display, which is visible on the Home Screen.
<b>Wallpaper</b>	Set a default or custom <b>User Images</b> for the Home Screen. A <b>Slideshow</b> is selected by default.
<b>Energy Saving</b>	Set <b>Auto Power On/Off</b> , <b>Power On Time</b> , <b>Power Off Time</b> , <b>Presence Detection</b> , <b>Eco Mode</b> , <b>OPS Always On</b> , <b>Display Sleep</b> .
<b>Picture</b>	Set <b>Scheme</b> , <b>Backlight</b> , and <b>Advanced Settings</b> for the display's picture; (Advanced Settings are only available when connects an input source)  *To adjust the backlight setting, <b>Eco Mode</b> must be disabled.
<b>Audio</b>	Set <b>Mute</b> , <b>Treble</b> , and <b>Bass</b> .
<b>Auto Close Menu</b>	Set <b>On</b> and <b>Off</b> .

## DISPLAY SETTINGS TIPS

The **Display** settings submenu contains configuration options for various picture and audio settings for your AVG series. Navigating the menus is straightforward and intuitive, but we'll provide some tips and knowhow to help you get started.

### Custom Wallpapers

The AVG series already comes with some gorgeous high-resolution wallpapers, but you can easily upload your own. Just follow these steps...

- I. **Grab a USB flash drive**
- II. Open the USB flash drive's *file directory* on a computer.
- III. Create a new folder with the name **WALLPAPER**.
- IV. Save any wallpapers you want into that **WALLPAPER** folder.
- V. **On the Display** - Open **Settings>Display>Wallpaper** on the Home Screen.
- VI. Under *User Images*, touch the blank tile containing the "+" symbol (see the image).
- VII. Plug your USB flash drive into the USB 3.0 port on the display.

That's it! Your custom wallpapers will upload automatically.



Only 1920x1080 images or higher resolutions are supported.



You can delete a custom wallpaper by touching the blue "x" button located on the right corner of the image preview.

### Energy Saving

This submenu provides options for helping you maximize power efficiency for your AVG series. Here you can...

- Schedule an **Auto Power On\*** cycle for every day of the week.
- Enable **Presence Detection** to wake the screen whenever it senses movement.
- Toggle **Eco Mode** for automatic *Energy Star* rated picture settings.
- Toggle **OPS Always On** to keep the OPS port live or have it shut off with the display's normal automatic or manual power cycles.
- Set your **Display Sleep** timer to activate after a set period of inactivity.

#### Auto Power On\*

Your automatic power schedule is divided into three items in the UiQ:

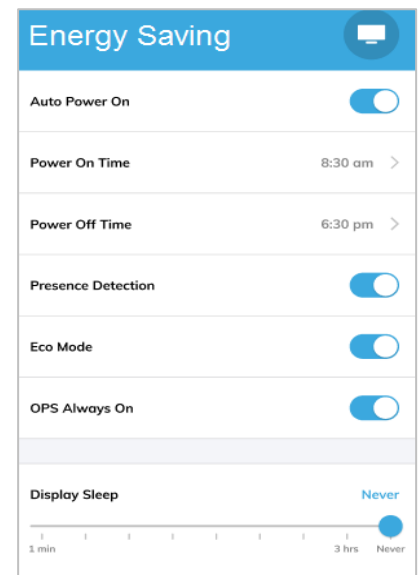
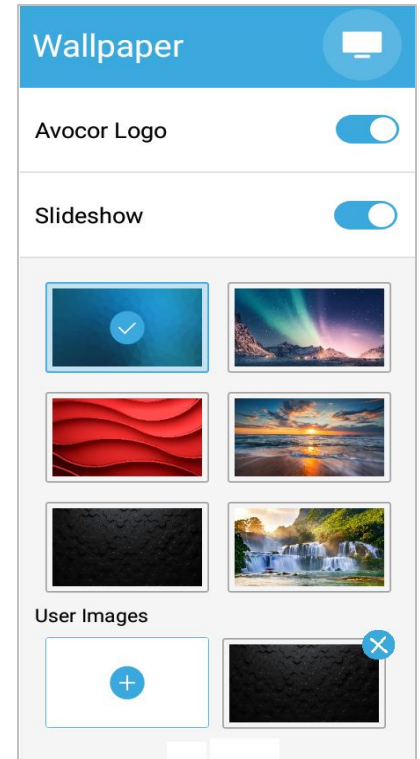

- **Auto Power On** – a slider which toggles your automatic power schedule on or off.
- **Power On Time** – sets the time your display will power on.
- **Power Off Time** – sets the time your display will power off.

Open either **Power On Time** or **Power Off Time** options and a clock wheel and seven tiles representing the days of the week will appear, just as in the image to the right. ----->

Simply adjust the clock to your preferred time of day and touch the days of the week to choose which days your Power On or Power Off will occur; **Blue** means active, **White** means inactive.

For example, if you set your **Power On Time** to 8:30 AM and highlight the *M, T, W, T, F* tiles, then your display will automatically power on at 8:30 AM, Monday thru Friday, while skipping Saturday and Sunday, every week.



*Utilizing these settings is highly recommended if you expect heavy use and long hours for your AVG series display, as this will help maintain its longevity.*

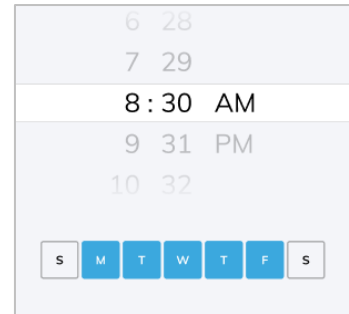

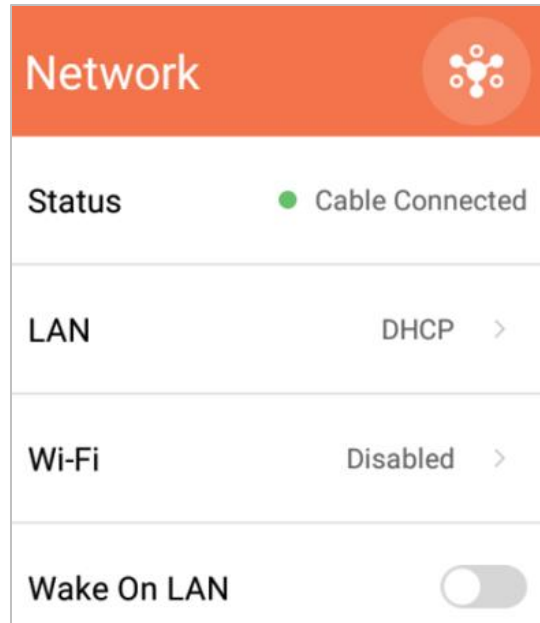

<b>Status</b>	Shows Network and LAN status ( <b>Cable Connected, Not Connected</b> ).
<b>LAN</b>	Set a <b>Static</b> IP or <b>DHCP</b> .
<b>Wi-Fi</b>	Configure Wi-Fi settings (additional USB device required)); locate the <b>MAC Address</b> .
<b>Wake On LAN</b>	Toggle <b>Wake On LAN</b> .

### NETWORK SETTINGS TIPS

Here is where you can set your **Network** configurations to enable a wired LAN connection, or a Wi-Fi connection (Wi-Fi USB device required). You also need to configure your **LAN** settings to be able to enable *TCP/IP control*.

Here are some tips to help get you started.

#### LAN

For a wired connection to either the **Ethernet In** or **Ethernet Out** port; here you'll assign an IP address and other necessary network parameters for your display. You can set your parameters manually by choosing the **Static** option or automatically via **DHCP**, if available. *Consult your network administrator to see if DHCP is an option!*

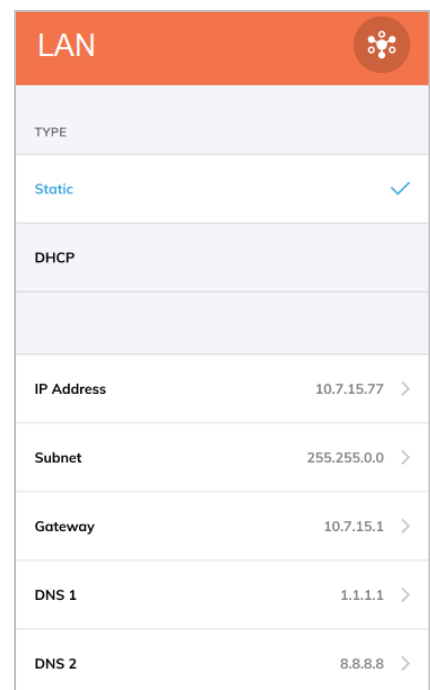

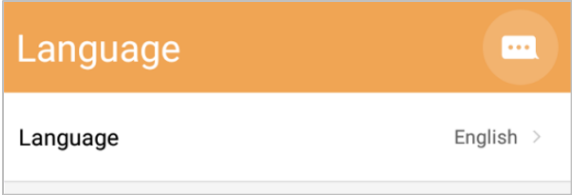

<b>Language</b>	Set the language for the display's user interface. Support English, French, German, Spanish, Italian and Dutch.
-----------------	---

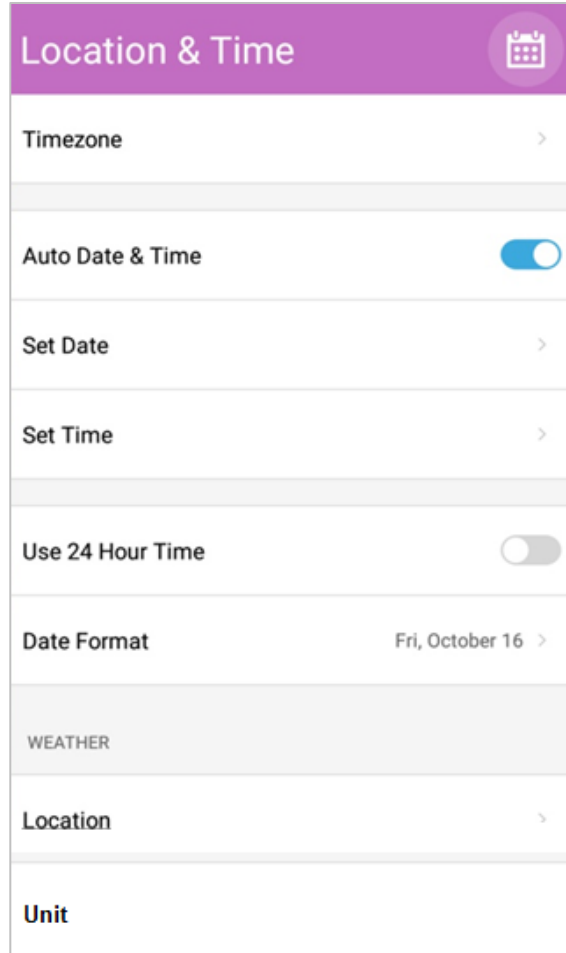

<b>Timezone</b>	Set Timezone based on city and region.
<b>Auto Date &amp; Time</b>	Toggle Auto Date & Time <b>On</b> (internet connection required, see NOTE below) or <b>Off</b> .
<b>Set Date</b>	Manually set the date.
<b>Set Time</b>	Manually set the time.
<b>Use 24 Hour Time</b>	Toggle 24 Hour Time <b>On</b> or <b>Off</b> .
<b>Date Format</b>	Set date format.
<b>Location (Weather)</b>	Set the region for accurate weather information.
<b>Unit (Weather)</b>	Set unit for measure of temperature (°F, °C)



**NOTE:** Enable automatic update setting, the display internet connection is required. There are two options for connecting to the internet :

- Plug an Ethernet cable into the display's network port
- Connect with an external Wi-Fi dongle on the display

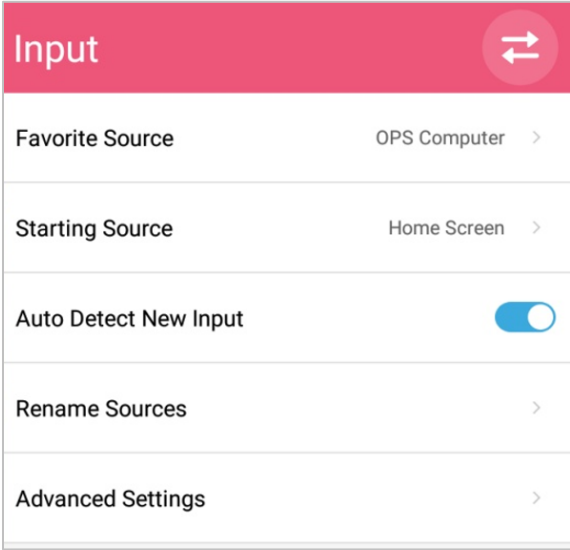

<b>Favorite Source</b>	Set the favorite source ( <b>Home Screen, OPS Computer, HDMI 1, HDMI 2, DisplayPort, Type-C</b> ).
<b>Starting Source</b>	Set the default source the display will show automatically upon powering on the display ( <b>Home Screen, OPS Computer, HDMI 1, HDMI 2, DisplayPort, Type-C</b> ).
<b>Auto Detect New Input</b>	Toggle <b>Auto Detect New Input</b> ; determines whether the display will automatically switch to a new connection.
<b>Rename Sources</b>	Set custom names for the display's input sources.
<b>Advanced Settings</b>	Toggle <b>Wake on Input</b> and set <b>EDID</b> .  Show the <b>Current Source's name, resolution and refresh rate</b>



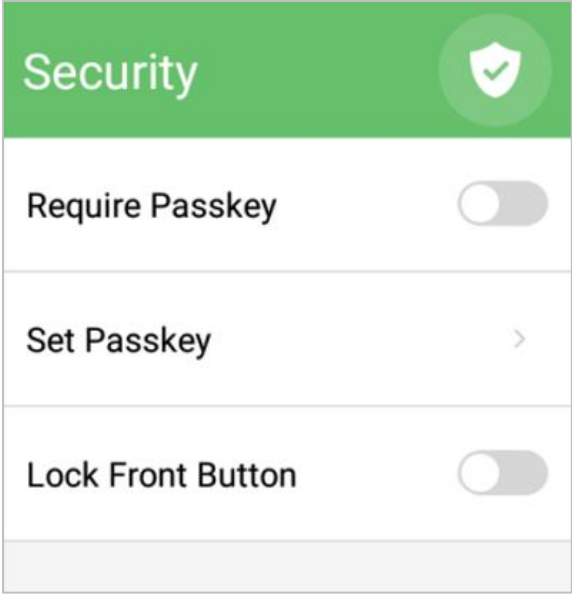

<b>Require Passkey</b>	Toggle Require Passkey on/off.
<b>Set Passkey</b>	Set a custom Passkey to access display settings.
<b>Lock Front Button</b>	Lock the buttons on the front panel.

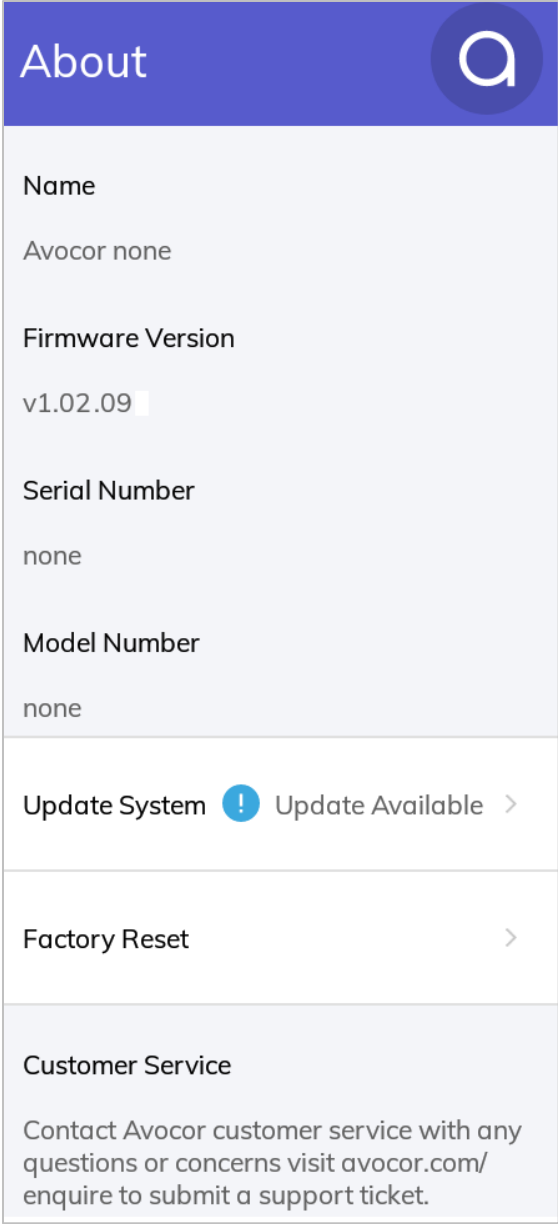

<b>Name</b>	The full name and model of the display.
<b>Firmware Version</b>	The active firmware version number.
<b>Serial Number</b>	The unique serial number for the display.
<b>Model Number</b>	The model number of the display.
<b>Update System</b>	Used to update the display's firmware.
<b>Factory Reset</b>	Used to restore the display's factory default settings.

## UPDATE SYSTEM – FIRMWARE

You can easily update your system firmware by opening the **About** menu in your display's OSD and clicking **Update System**.

From here, you have two options:

### 1. Download & Apply Update

- This will allow you to easily update your firmware over a stable internet connection. We recommend using a wired connection to ensure the process is successful.



**NOTE:** This function will only support FW version **1.03** or higher.

### 2. USB Update

- This is a more manual process that requires you to download the correct file from Avocor.com, and upload the file via the USB Service Port on the display.



**NOTE:** This function will only support FW version **1.02** or higher

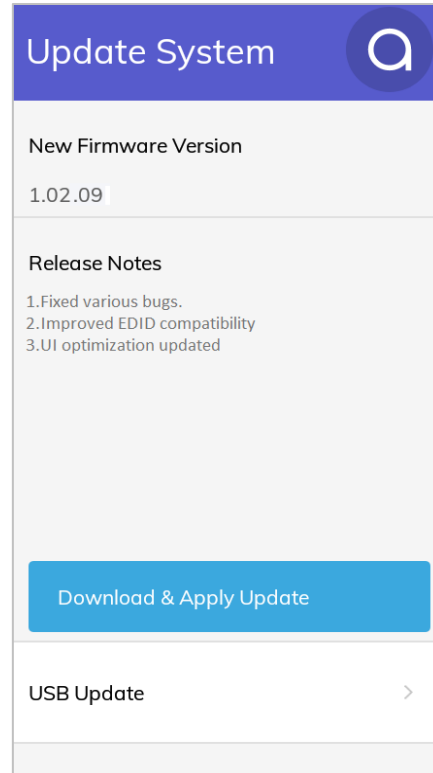

### *Download & Apply Update – Instructions (FW version 1.03 or higher)*

Connecting through an Ethernet network on your display, the system can automatically detect the updates and enable firmware upgrading within a few steps.

- The system will check the Avocor website and display the **Update Available** dialog message if there is new firmware version.
- Open the **About** menu > **Update System** > **Update Available**.

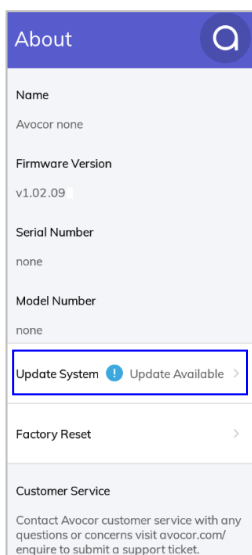

3. Press **Download & Apply Update**.

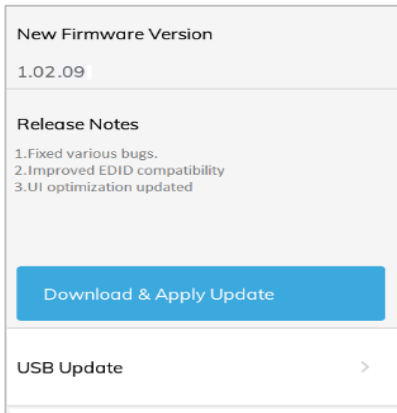

4. A dialogue box shows there is a new firmware available then click the **Install** button to proceed.

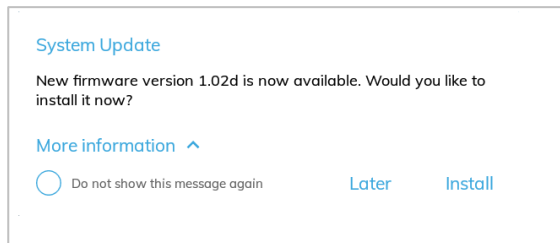

5. After selecting the **Install button**, a progress bar will appear as the download process begins. When the installation reaches 100%, the display will restart.

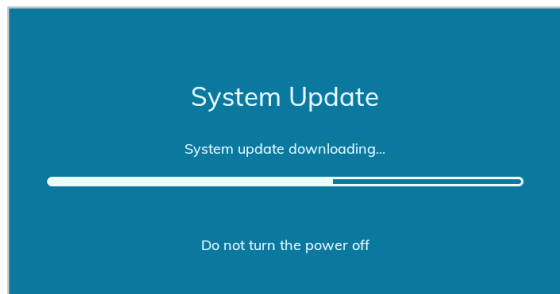

6. Once the firmware updating is finished, it will take a few minutes to restart the display.

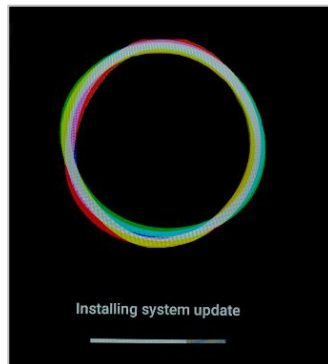

7. Wait until the process complete and the display shows again the Home screen. Go to the About menu and check if the new version is up to date.

### **USB Update – Instructions (FW version 1.02 or higher)**

For your convenience, detailed instructions will appear once you open the USB Update option in the OSD menu.



1. Download the firmware update by selecting the relevant display from: <https://www.avocor.com/support/> and then selecting firmware.
2. Change the name of the downloaded firmware file name to update\_signed.zip
3. Prepare a USB stick formatted to FAT32.
4. Copy the renamed update\_signed.zip firmware file onto the USB stick.
5. Connect the USB stick to the **Service USB Port** on the display.



Once a compatible USB Stick has been detected, the

**Insert USB** button will highlight and change to:



You can then press the button, and the update will apply automatically.

## EXTERNAL CONTROL

### RS232 Connection and Port Configuration

Connect your control system or PC to the RS232 input of the display via a 9-pin, straight through connector cable. Configure the RS232 controller or PC serial port as follows: no parity, 8 data bits, 1 stop bit and no flow control. Set the baud rate to 115200, to match that of the display RS232 port.

### TCP/IP Control Configuration

Connect your network, control system, or PC to the display's **Ethernet In** or **Ethernet Out** port via a CAT5 cable. The display must be connected to the network and must have a valid IP address. Configure your control system to run through **Telnet (Port 23)**.

### Command and Response Format

Any commands sent from an automation/control system or PC to an Avocor display must have the following format (**ASCII is not accepted/used**) :

[STX] [IDT] [TYPE] [CMD] [VALUE]/[REPLY] [ETX]

- [STX] indicates the start of the command data (always 07).
- [IDT] is the display ID (always 01).
- [TYPE] is the command type:
  - 00 = return to host (response from the LCD panel)
  - 01 = read / action
  - 02 = write
- [VALUE] is the parameter setting for the command.
- [REPLY] is the parameter setting for the command, acknowledged by the display in its response to a command.
- [ETX] indicates the end of the command data (always 08).

## Serial Command List

Main Item	Control Item	CMD	Type	Value (HEX)	Reply (HEX)	Content	CMD (HEX)
Power Control and Input Source	Power Control	POW	W/R	00	00	Off (soft power)	50 4F 57
				01	01	On (soft power) *NOTE	
	IPC Control	IPC	W/R	00	00	Off	49 50 43
				01	01	On	
	Input Source	MIN	W/R	09	09	HDMI 1	4D 49 4E
				0A	0A	HDMI 2	
				0D	0D	DisplayPort	
				0E	0E	IPC/OPS	
				14	14	Type-C	
	Display Adjustment	Display Adjustment	BRI	W/R	00~64	00~64	Back Light Brightness
BRL			W/R	00~64	00~64	Digital Brightness Level	
BLC			W/R	00	00	Off (Back Light)	42 4C 43
				01	01	On (Back Light)	
CON			W/R	00~64	00~64	Contrast	43 4F 4E
HUE			W/R	00~64	00~64	Hue	48 55 45
SAT			W/R	00~64	00~64	Saturation	53 41 54
COT			W/R	01	01	6500K	43 4F 54
				02	02	9300K	
				06	06	5000K	
				07	07	7500K	
GAC			W/R	00	00	Gamma Off	47 41 43
				01	01	Gamma 2.2	
Sharpness	SHA	W/R	00~64	00~64	Sharpness	53 48 41	

Main Item	Control Item	CMD	Type	Value (HEX)	Reply (HEX)	Content	CMD (HEX)					
Other Control	Baudrate Adjustment	BRA	W/R	00	00	115200	42 52 41					
				01	01	38400						
				02	02	19200						
				03	03	9600						
	Other Control		RCU	W	00	00	MENU Key	52 43 55				
					01	01	INFO Key					
					02	02	UP Key					
					03	03	DOWN Key					
					04	04	LEFT Key					
					05	05	RIGHT Key					
					06	06	ENTER Key					
					07	07	EXIT Key					
					0A	0A	HDMI1 Key					
					0B	0B	HDMI2 Key					
					0C	0C	DISPLAYPORT Key					
					12	12	SOURCE Key					
					18	18	FREEZE Key					
					19	19	MUTE Key					
					1D	1D	VOLUME+ Key					
					1E	1E	VOLUME- Key					
					21	21	OPS Key					
					2E	2E	Type-C Key					
						ALL	W		00	00	Reset all	41 4C 4C
						KLC	W/R		00	00	Un-lock keys	4B 4C 43
		01	01	Lock keys								



Main Item	Control Item	CMD	Type	Value (HEX)	Reply (HEX)	Content	CMD (HEX)
		SER	R		13 bytes	Read Serial Number	53 45 52
		MNA	R		13 bytes	Read Model Name	4D 4E 41
		GVE	R		6 bytes	Read Firmware Version	47 56 45
	Audio	VOL	W/R	00~64	00~64	volume	56 4F 4C
		BAS	W/R	00~0D	00~0D	Bass	42 41 53
		TRE	W/R	00~0D	00~0D	Treble	54 52 45
		BAL	W/R	00~0D	00~0D	Balance	42 41 4C
		INS	W/R	00	00	Internal Speaker Off	49 4E 53
				01	01	Internal Speaker On	
		MUT	W/R	00	00	Mute Off	4D 55 54
	01			01	Mute On		
	Scheme Selection	SCM	W/R	00	00	User/Custom	53 43 4D
				01	01	Sport	
				02	02	Game	
				03	03	Cinema	
				04	04	Vivid	
	Eco Mode	WFS	W/R	00	00	Eco Off	57 46 53
				01	01	Eco On	
	RTC	RTY	W/R	00~63	00~63	Set Real time Year	52 54 59
		RTM	W/R	01~0C	01~0C	Set Real time Month	52 54 4D
		RTD	W/R	01~1F	01~1F	Set Real time Day	52 54 44
RTH		W/R	00~17	00~17	Set Real time Hour	52 54 48	
RTN		W/R	00~3B	00~3B	Set Real time Minute	52 54 4E	
Smart Light Control	SLC	W/R	00	00	Off	53 4C 43	
			02	02	Light Sensor		

Main Item	Control Item	CMD	Type	Value (HEX)	Reply (HEX)	Content	CMD (HEX)
	HDMI1 EDID	EH1	W/R	00	00	1080P	45 48 31
				02	02	4K60Hz	
	HDMI 2 EDID	EH2	W/R	00	00	1080P	45 48 32
				02	02	4K60Hz	
	OPS EDID	EH5	W/R	00	00	1080P	45 48 35
				02	02	4K60Hz	
	DisplayPort 1 EDID	ED1	W/R	00	00	1080P	45 44 31
				02	02	4K60Hz	
	Type-C EDID	EC1	W/R	00	00	1080P	45 43 31
				02	02	4K60Hz	
	HDMI RGB Color Range	HCR	W/R	00	00	Auto Detect	48 43 52
				01	01	Full Range	
				02	02	Limited Range	
	OSD Language	OSL	W/R	00	00	English	4F 53 4C
				01	01	French	
				02	02	German	
				03	03	Dutch	
				0D	0D	Italian	
10				10	Spanish		
Ethernet Setup	Network Enable	NWE	W/R	00	00	No	4E 57 45
				01	01	Yes	
	Dynamic IP	DIP	W/R	00	00	Disable	44 49 50
				01	01	Enable	
	Static IP Settings	IP1	W/R	00~FF	00~FF	Static IP Address 1	49 50 31
		IP2	W/R	00~FF	00~FF	Static IP Address 2	49 50 32

Main Item	Control Item	CMD	Type	Value (HEX)	Reply (HEX)	Content	CMD (HEX)
		IP3	W/R	00~FF	00~FF	Static IP Address 3	49 50 33
		IP4	W/R	00~FF	00~FF	Static IP Address 4	49 50 34
		MK1	W/R	00~FF	00~FF	Subnet Mask 1	4D 4B 31
		MK2	W/R	00~FF	00~FF	Subnet Mask 2	4D 4B 32
		MK3	W/R	00~FF	00~FF	Subnet Mask 3	4D 4B 33
		MK4	W/R	00~FF	00~FF	Subnet Mask 4	4D 4B 34
		GW1	W/R	00~FF	00~FF	Gateway 1	47 57 31
		GW2	W/R	00~FF	00~FF	Gateway 2	47 57 32
		GW3	W/R	00~FF	00~FF	Gateway 3	47 57 33
		GW4	W/R	00~FF	00~FF	Gateway 4	47 57 34
		FD1	W/R	00~FF	00~FF	DNS Address 1	46 44 31
		FD2	W/R	00~FF	00~FF	DNS Address 2	46 44 32
		FD3	W/R	00~FF	00~FF	DNS Address 3	46 44 33
		FD4	W/R	00~FF	00~FF	DNS Address 4	46 44 34
				SNS	W	00	00
		MAC	W	00~05	00~FF	Querying MAC ID #0~#5	4D 41 43
OPS	OPS Always Power	OAP	W	00~01	00~01	Configure OPS Always Power setting	4F 41 50
Sensor	Enable Presence Sensor	SPR	W/R	00	00	Disable Presence Sensor	53 50 52
				01	01	Enable Presence Sensor	
	Read Motion Status	RPR	R	-	00	There is not people motion	52 50 52
				-	01	People motion	



**NOTE:** Power On command (POW 1) is only applicable when **Eco Off** and the display is in **power off** or **standby state**.

## WARRANTY INFORMATION

### COVERAGE

Avocor warrants to the first end user customer that the product, when shipped in its original container, will be free from defective workmanship and materials, and agrees that it will, for a period of **three (3) years** from the date of purchase, repair or replace the defective product or part thereof, at Avocor's discretion, with a new or equivalent at no charge to the customer. Advanced Field Replacement (AFR) service is included as part of this warranty.

Except as specified herein, this warranty covers all defects in material or workmanship in the product. AVOCOR'S LIABILITY FOR ANY DEFECTIVE PRODUCT IS LIMITED TO THE REPAIR OR REPLACEMENT OF THE PRODUCT AT AVOCOR'S DISCRETION. REPLACEMENT PARTS OR PRODUCTS MAY BE NEW OR 'LIKE NEW' UNDER THE CONDITIONS SPECIFIED BELOW. All parts or products removed under this warranty become the property of Avocor.

The replacement part or product is warranted for the remainder of the original limited warranty period or thirty days from shipment, whichever is longer.

LIMITATIONS ON WARRANTY COVERAGE, DURATION, AND SERVICES MAY SOMETIMES VARY BASED ON THE LAWS OF SPECIFIC REGIONS, STATES, AND COUNTRIES. THIS LIMITED WARRANTY GIVES YOU SPECIFIC LEGAL RIGHTS, AND YOU MAY HAVE OTHER RIGHTS WHICH VARY FROM JURISDICITON TO JURISDICTION.

### Exclusions

This warranty does not apply to any cosmetic or consumable items of the Product or if the serial number or model number affixed to the Product has been removed, defaced, changed, altered or tampered with.

This warranty does not cover installation, signal reception problems, potential incompatibility with peripheral devices, or acts of nature. Avocor does not warrant nor shall it be liable for Products which have been subject to abuse, including, but not limited to, improper voltage, accident, misuse, negligence, lack of reasonable care, alteration, modification, tampering, improper installation, shipping damage, operation or maintenance or any damages or defects caused by repairs or attempted repairs performed by anyone other than Avocor personnel or an Avocor-authorized servicer.

Please refer to Avocor's pixel policy for warranty guidelines on pixel related issues.

This warranty also excludes any damage to product glass due to pressure, abrasion, scratches, or actions otherwise beyond normal operation of the product that would cause screen mura and image retention (see PRECAUTION on page 31).

## Concealed Damage

It is the customer's responsibility to inspect new product(s) at the time of delivery.

If packaging is found damaged *at the time of delivery*, the Customer should refuse delivery and note on the delivery receipt the product and details pertaining to damage. The Customer may accept packages with minor damage but must take note of product details and damage on the delivery receipt.

If patent or obvious physical damage is detected *after delivery is accepted* and a "clean" or unmarked delivery receipt was returned, it is the customer's responsibility to file an insurance claim to the shipping provider according to the requirements set forth in the shipping provider's policy.

If the product packaging is clean and undamaged, but patent or obvious physical damage is found on the product, the customer must report the damages to their product distributor, shipper, or seller, within the policy guidelines of the distributor, shipper, or seller.

If freight was arranged by Avocor, and patent or obvious physical damage to the packaging is not detected but found on the product or product accessories upon inspecting the product, the customer must report the damages to Avocor within 10 calendar days after the delivery date to receive warranty services.

## Customer Data

If the customer's product is capable of storing software programs, data, and other information, it is the customer's responsibility to protect its contents against operational failure. It is also the customer's responsibility to keep a separate backup of the contents and remove all personal information and disable security passwords prior to delivering a product for warranty service. ANY PERSONAL CONTENT WILL BE DELETED AND STORAGE MEDIA WILL BE REFORMATTED IN THE COURSE OF WARRANTY SERVICE.

**AVOCOR SHALL NOT BE LIABLE, OR IN ANY WAY RESPONSIBLE, FOR ANY INCIDENTAL OR CONSEQUENTIAL ECONOMIC OR PROPERTY DAMAGE. SOME REGIONS DO NOT ALLOW LIMITS ON WARRANTIES OR ON REMEDIES FOR BREACH IN CERTAIN TRANSACTIONS; IN SUCH REGIONS, THE LIMITS HEREIN MAY NOT APPLY. THIS WARRANTY IS IN LIEU OF ALL OTHER WARRANTIES, EXPRESSED OR IMPLIED. AVOCOR DISCLAIMS ALL OTHER WARRANTIES, EXPRESSED OR IMPLIED, INCLUDING, BUT NOT LIMITED TO, IMPLIED WARRANTIES OF NON-INFRINGEMENT, MERCHANTABILITY, AND FITNESS FOR A PARTICULAR PURPOSE.**

## SERVICES

**Technical Support:** The Customer must contact Avocor Technical Support, via email at [service@avocor.com](mailto:service@avocor.com) in order to initiate an RMA or another warranty service. Customer agrees to cooperate with Avocor: (A) to notify Avocor promptly of any defect, error or Hardware Product malfunction and to submit to Avocor such information that Avocor may reasonably require to reproduce the error or Hardware Product malfunction and the operating conditions under which the error or Hardware Product malfunction was discovered; (B) to follow Avocor's guidelines to troubleshoot reported faults on the defective product(s); (C) to install,

requested by Avocor and within Customer security guidelines, a network connection that will be made available to Avocor for the purpose of resolving problems, reviewing Customer use of software, or for any other reasonable purpose; (D) to have a certified technician repair or replace defective parts under Avocor's guidance; (E) to notify Avocor of any additional hardware or software not purchased from Avocor that may be used in conjunction with the Hardware Product.

**Onsite Repair:** If Avocor deems the Product repairable, it will, at its discretion, send a technical support representative and/or technician to provide onsite repair or replacement service for any repairable or replaceable parts. Customer may be asked to provide access to, and to assist in the handling of, the Product, as deemed necessary by Avocor, under the instruction of the field representative or technician.

**Advance Field Replacement (AFR):** Avocor will ship a like-new or refurbished replacement product to the customer, at its discretion, if the product defect is determined to be unrepairable. The Customer must provide the display model and serial number and will be asked to provide contact details for the shipment. Upon approval, Avocor will ship the replacement product to the customer's site.

**AFR Guidelines:** At the time of the new product's arrival to the customer, it is the customer's responsibility to facilitate the deinstallation of the defective product, installation of the replacement product, and packing of the defective product in either its original packaging or the packaging of the replacement, and then send the defective back with the same driver that delivered the replacement product on that same day. If the customer is not able to perform the same-day swap they will incur the cost of freight. Additionally, if the product is not returned within 15 business days, the customer will be invoiced in full for the replacement product.

SHIPMENTS TO CERTAIN INTERNATIONAL LOCATIONS MAY NOT BE SUBJECT TO THE ABOVE AFR GUIDELINES. CONTACT SUPPORT FOR FURTHER DETAILS.

**Defective on Arrival (DOA):** If the Product is determined by Avocor to be defective within the first 90 days of the initial purchase by the Customer, it is deemed Defective on Arrival (DOA). In the case of a DOA, the Customer will be provided a brand-new equivalent Product. In the case that an RMA is issued after the 90 DOA period, the defective product will be replaced with a refurbished "like new" equivalent product, if available.

**Repair with Expired Warranty:** Avocor offers repair services, at cost to the Customer based on time and materials, for products with expired warranty. Customer will be responsible for all shipment costs.

---

*For more information, please contact us via email at [service@avocor.com](mailto:service@avocor.com)*