



User Guide

© Copyright 2019 HP Development Company, L.P.

Windows is either a registered trademark or trademark of Microsoft Corporation in the United States and/or other countries.

The information contained herein is subject to change without notice. The only warranties for HP products and services are set forth in the express warranty statements accompanying such products and services. Nothing herein should be construed as constituting an additional warranty. HP shall not be liable for technical or editorial errors or omissions contained herein.

Fifth Edition: April 2019

First Edition: March 2018

Document Part Number: L14947-005

Product notice

This guide describes features that are common to most models. Some features may not be available on your product. To access the latest user guide, go to <http://www.hp.com/support>, and follow the instructions to find your product. Then select **User Guides**.

Software terms

By installing, copying, downloading, or otherwise using any software product preinstalled on this computer, you agree to be bound by the terms of the HP End User License Agreement (EULA). If you do not accept these license terms, your sole remedy is to return the entire unused product (hardware and software) within 14 days for a full refund subject to the refund policy of your seller.

For any further information or to request a full refund of the price of the computer, please contact your seller.

About This Guide

This guide provides basic information for using and upgrading this product.





-
-  **WARNING!** Indicates a hazardous situation that, if not avoided, **could** result in death or serious injury.
 -  **CAUTION:** Indicates a hazardous situation that, if not avoided, **could** result in minor or moderate injury.
 -  **IMPORTANT:** Indicates information considered important but not hazard-related (for example, messages related to property damage). Warns the user that failure to follow a procedure exactly as described could result in loss of data or in damage to hardware or software. Also contains essential information to explain a concept or to complete a task.
 -  **NOTE:** Contains additional information to emphasize or supplement important points of the main text.
 -  **TIP:** Provides helpful hints for completing a task.
-

Table of contents

1 Product features	1
Base module features	1
Top components	1
Rear components	2
Side components	3
Regulatory information and serial number location	3
HP Video Ingest Module	4
HP Wireless Display Module and receiver (optional)	4
Wireless Display Module	4
Wireless receiver	5
HP Optical Disc Drive (ODD) Module (optional)	5
HP VESA Plate (optional)	6
HP Center of Room Control (CoRC) Module	6
2 Setup	7
Connecting or removing modules	7
Connecting modules	7
Connecting the optional VESA Plate	8
Removing modules	10
Attaching the product to a mounting device	11
Installing a security cable (optional)	11
Connecting AC power	12
Setting up a conferencing solution	13
Microsoft Teams Rooms conferencing solution	13
Intel Unite solution	20
3 Hardware upgrades	26
Serviceability features	26
Warnings and cautions	26
Removing and replacing the access panel	27
Removing the access panel	27

Replacing the access panel	28
Locating internal components	28
Upgrading system memory	29
Memory module specifications	29
Populating memory module slots	30
Installing system memory modules	31
Removing and replacing a SATA SSD	33
Appendix A Electrostatic discharge	35
Preventing electrostatic damage	35
Grounding methods	35
Appendix B Computer operating guidelines, routine care and shipping preparation	36
Computer operating guidelines and routine care	36
Shipping preparation	37
Appendix C Accessibility	38
Accessibility	38
Finding the technology tools you need	38
Our commitment	38
International Association of Accessibility Professionals (IAAP)	39
Finding the best assistive technology	39
Assessing your needs	39
Accessibility for HP products	39
Standards and legislation	40
Standards	40
Mandate 376 – EN 301 549	40
Web Content Accessibility Guidelines (WCAG)	40
Legislation and regulations	41
United States	41
21st Century Communications and Video Accessibility Act (CVAA)	41
Canada	42
Europe	42
United Kingdom	42
Australia	42
Worldwide	43
Useful accessibility resources and links	44
Organizations	44
Educational institutions	44
Other disability resources	44

HP links	44
Contacting support	45
Index	46

1 Product features

Base module features

Top components

The top components enable call control with capacitive touch buttons for conference calls.

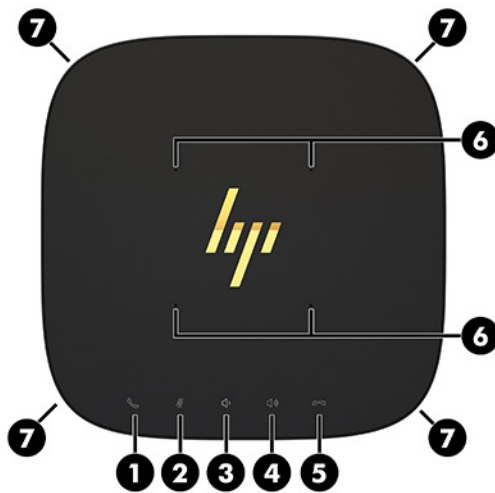

Item	Component	Item	Component
1	Answer/Call	5	Reject/Disconnect call
2	Mute	6	Microphones
3	Volume down	7	Speakers
4	Volume up		



IMPORTANT: Do not set anything on top of the system or allow liquids to get on top of the system.

Rear components



Item	Component	Item	Component
1	Power button	6	USB ports (2)
2	Disc activity light	7	Dual-Mode DisplayPort (D++) connector
3	Power connector	8	HDMI port
4	RJ-45 (network) jack	9	Security cable slot
5	USB Type-C power connector and port		

NOTE: On the Microsoft Teams Rooms conferencing solution, this port is designated for the HP Center of Room Control (CoRC) Module.

Side components



Item	Component	Item	Component
1	USB Type-C port (disabled at factory, enabled through system BIOS)	2	Audio-out (headphone)/Audio-in (microphone) combo jack

NOTE: This USB Type-C port does not provide power for a monitor.

Regulatory information and serial number location

Each base module has a unique serial number and a product ID number laser-etched on the base cover. A copy of these labels is inside the case. Keep these numbers available for use when contacting support for assistance.

NOTE: If optional modules are attached to the base module, you must remove the modules to view the serial number and product ID number.



Item	Component	Item	Component
1	Regulatory label	3	Module connector
2	Regulatory and service information		

HP Video Ingest Module

The Video Ingest Module is required for installation of the Microsoft Teams Rooms software. This module enables a video source, such as a notebook computer, to be connected to Microsoft Teams Rooms.

The Video Ingest Module is not available for the Intel Unite solution.

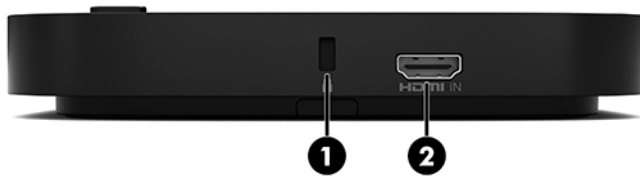

Item	Component	Item	Component
1	Security cable slot	2	HDMI-in port

HP Wireless Display Module and receiver (optional)

The Wireless Display Module and receiver may be included with the Microsoft Teams Rooms or the Intel Unite solution. The receiver can be attached to a monitor and the Wireless Display Module can transmit a signal up to 8 meters to the receiver in the room.

An HDMI cable and USB Micro-B cable are included with the Wireless Display Module and receiver.

The Wireless Display Module is not available in all countries. Contact your seller for country support.

NOTE: The Wireless Display Module and receiver are paired at the factory but can be re-synchronized if necessary. See [Setting up a conferencing solution on page 13](#) for more information.

TIP: For the best performance, be sure that the line of sight between the receiver and the Wireless Display Module is unobstructed.

Wireless Display Module

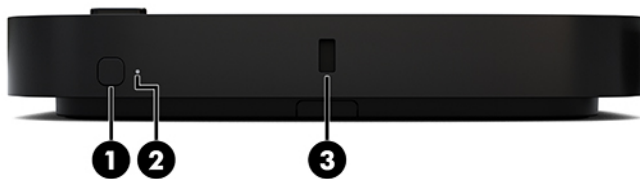

Item	Component	Item	Component
1	Sync button	3	Security cable slot
2	Sync light		

Wireless receiver

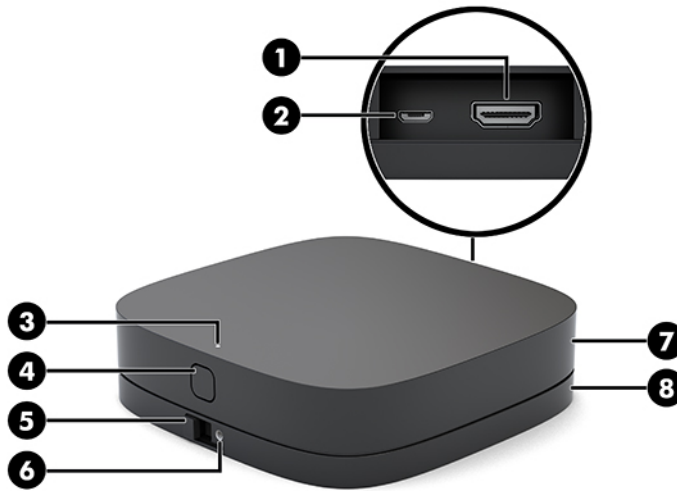

Item	Component	Item	Component
1	HDMI port	5	VESA plate release button
2	USB Micro-B power connector	6	VESA plate screw hole for locking the release button
3	Sync light	7	Wireless receiver
4	Sync button	8	Wireless receiver VESA plate

HP Optical Disc Drive (ODD) Module (optional)

The optional ODD Module (purchased separately) provides optical drive functionality. Additional optical drive modules may be connected depending upon the power supply and the total number of powered modules.

The HP Optical Disc Drive (ODD) Module may be purchased separately for the Microsoft Teams Rooms or the Intel Unite solution.

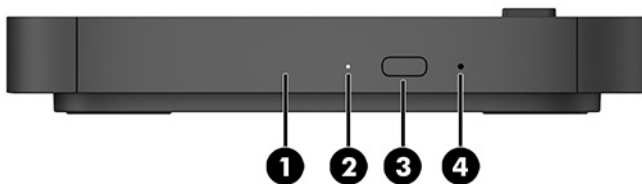

Item	Component	Item	Component
1	Optical drive disc tray	3	Optical drive eject button
2	Optical drive light	4	Manual eject hole

HP VESA Plate (optional)

The optional HP VESA Plate enables the assembly to be mounted onto a table. The product should not be mounted to a wall or under a desk.

The HP VESA Plate may be included with the Microsoft Teams Rooms or the Intel Unite solution. It can also be purchased separately.

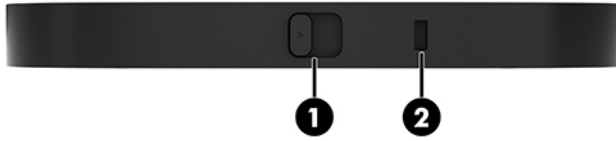

Item	Component	Item	Component
1	Quick release latch	2	Security cable slot

HP Center of Room Control (CoRC) Module

The HP Center of Room Control (CoRC) Module allows the meeting leader to easily manage the meeting by starting meetings, adding meeting members, sharing content, and ending meeting functions. It is included with Microsoft Teams Rooms.

NOTE: The HP Center of Room Control (CoRC) Module is required for the Microsoft Teams Rooms conferencing solution. It is not available for the Intel Unite solution.



2 Setup

Connecting or removing modules

Additional modules may be attached to the base module in the following order, from top to bottom:

- Video Ingest Module (required for Microsoft Teams Rooms only)
- Wireless Display Module (optional)
- ODD Module (optional)
- VESA Plate (optional)

Connecting modules



IMPORTANT: Before connecting modules, turn off the base module and disconnect it from any AC power source.

Modules cannot be “hot-plugged” or “hot-swapped.”

1. Remove/disengage the security cable, if one is attached.
2. Remove all removable media, such as USB flash drives.
3. Turn off the base module properly through the operating system, and then turn off any external devices.
4. Disconnect the AC power cord from the base module and disconnect any external devices.
5. If the VESA Plate is connected, slide the quick release latch to the unlocked position and remove the VESA Plate.

6. Align the module connection port on the underside of the base module with the module expansion connector on the new module and press the base module down firmly.



You should hear a quiet click when the modules lock together. The module locks into place and hides the release latch of the module above it.

Repeat until all modules have been connected.

Connecting the optional VESA Plate

If the VESA Plate is connected, the product can be mounted onto a table.

1. Slide the quick release latch on the VESA Plate to the unlocked position. Position the connected modules over the VESA Plate.

The VESA Plate does not have a module expansion connector. Be sure that the ports of the base module and the quick release latch and security cable slot of the VESA Plate are all on the same side.

2. Press the modules down onto the VESA Plate.



3. Slide the quick release latch on the back of the VESA Plate to the locked position to lock all modules together.

 **IMPORTANT:** There are four tabs in the VESA Plate. When you position the configuration correctly onto the VESA Plate and slide the quick release latch to the locked position, the four tabs lock the VESA Plate to the assembly. If the VESA Plate is not correctly oriented, the quick release latch cannot be moved to the locked position and the modules are not secured.



4. Install a security cable in the VESA Plate security cable slot to prevent the quick release latch from being unlocked and the modules from being separated.

 **NOTE:** The security cable is designed to act as a deterrent, but it may not prevent the device from being mishandled or stolen.

Removing modules

 **IMPORTANT:** Before disconnecting modules, turn off the base module and disconnect it from any AC power source.

Modules cannot be “hot-plugged” or “hot-swapped.”

Modules must be removed one at a time, starting at the bottom. Removing the bottom module exposes the release latch of the module above it.

1. Remove/disengage the security cable, if one is attached.
2. Remove all removable media, such as USB flash drives.
3. Turn off the base module properly through the operating system, and then turn off any external devices.
4. Disconnect the AC power cord from the base module and disconnect any external devices.
5. If the VESA Plate is connected, slide the quick release latch on the back of the VESA Plate to the unlocked position and lift the module stack off the VESA Plate.
6. Beginning at the bottom, remove additional modules by pressing the release latch (1) on the underside of each module until it releases the module (2) above it.



Attaching the product to a mounting device

If the VESA Plate, available as an option, is connected, the product can be attached to a table.

To mount the product:

1. Connect all modules except the VESA Plate.
2. Use the four screws provided with the VESA Plate to attach the VESA Plate to a table or other surface.

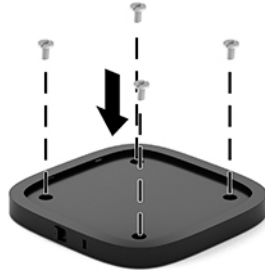

3. Carefully connect the modules to the VESA Plate.
4. Slide the quick release latch on the rear of the VESA Plate to the locked position to secure the VESA Plate to the module above it.

 **NOTE:** HP highly recommends that you secure the assembly by attaching a security cable to the rear of the VESA Plate. This stops the quick release latch from being moved to the unlocked position and prevents accidental release of the modules.

The security cable is designed to act as a deterrent, but it may not prevent the device from being mishandled or stolen.

Installing a security cable (optional)

The optional 10 mm ultra-slim cable lock displayed below can be used to secure modules stacked together. A security cable lock can be connected to the base module, the Video Ingest module, the Wireless Display module, or the VESA Plate. When installed in the bottom module, the cable locks all modules together. If the VESA Plate is installed, slide the quick release to the locked position and install a security cable (1) to lock all modules together. Use the key (2) provided to lock and unlock the security cable.

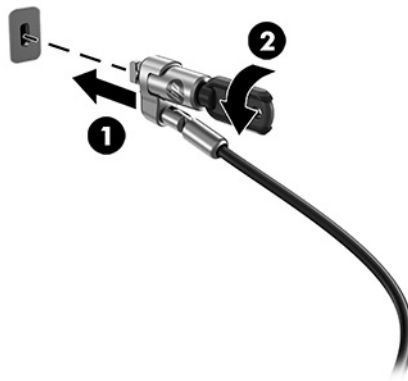



NOTE: The security cable is designed to act as a deterrent, but it may not prevent the device from being mishandled or stolen.

Connecting AC power

The HP Cable and Port Cover supplies power to the elements of the conferencing solution.

1. Connect the Cable and Port Cover to the base module:
 - a. Pull the port cover (1) down to expose the cable connectors.
 - b. Pull the first and last connectors (2) back and then out to each side.

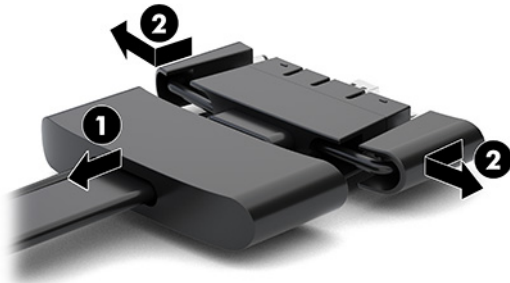

- c. Beginning with the DisplayPort connector and finishing with the NIC connector, plug all middle connectors (1) into the rear ports on the base module.
 - d. Connect the first connector (2) and last connector (3).
 - e. Push the port cover (4) back over the cable connectors to protect and secure the connectors.



2. Connect remaining equipment, such as a CoRC or a monitor, to the Cable and Port Cover.
3. Connect the AC power cord to the AC adapter (1) and the other end to an AC outlet (2).

4. Connect the AC adapter to the power connector on the Cable and Port Cover (3).

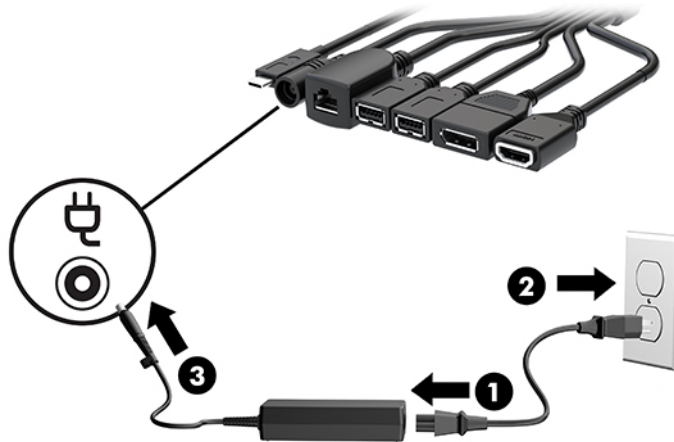

Setting up a conferencing solution

The product has two conferencing solutions:

- **Microsoft Teams Rooms**

 **NOTE:** For more information, go to <https://docs.microsoft.com>.

- **Intel Unite solution**

 **NOTE:** For more information, go to www.intel.com/Unite.

Microsoft Teams Rooms conferencing solution

The image below shows the Microsoft Teams Rooms wiring diagram.

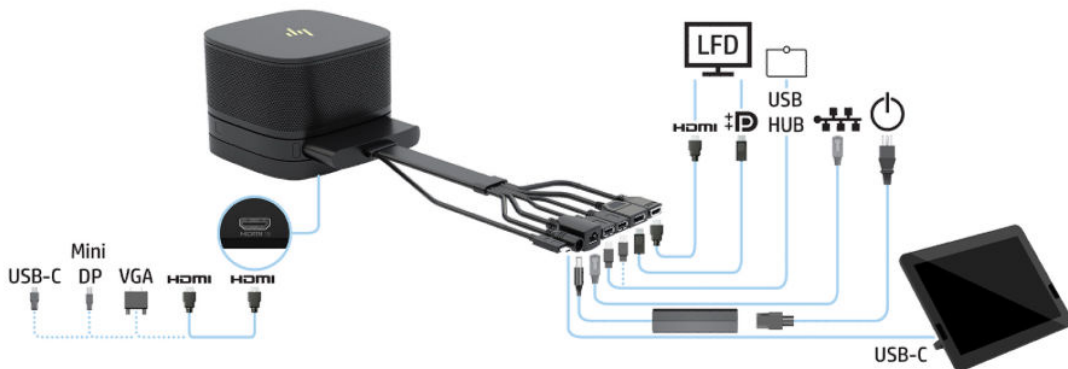

 **TIP:** When routing cables under a table or other surface, use cable guides to minimize stress on the cables.

1. Connect the Video Ingest Module (required).
2. Connect additional modules, if desired.

3. Place the assembly in a central location.

Be sure that nothing is placed on top of or next to the assembly that could block speakers and microphones.

4. Connect the Cable and Port Cover:

- a. Pull the port cover (1) down to expose the cable connectors.
- b. Pull the first and last connectors (2) back and then out to each side.

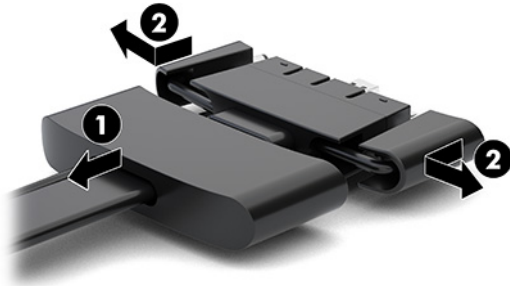

- c. Beginning with the HDMI connector and finishing with the NIC connector, plug all middle connectors (1) into the rear ports on the base module.
- d. Connect the first connector (2) and last connector (3).
- e. Push the port cover back over the cable connectors (4) to protect and secure the connectors.



5. Connect the CoRC.

- a. Connect the USB-C cable from the top of the Cable and Port Cover to an exit port on the rear of the CoRC (1). Press the cable into the channel (2) to exit on either the left or right side of the CoRC.

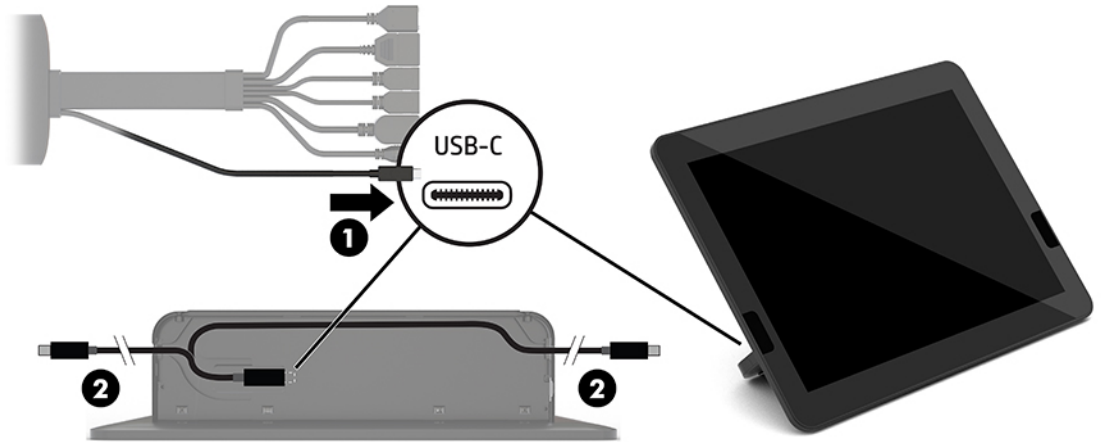

- b.** Remove the CoRC back cover from the shipping box (1).
- c.** Remove the rubber plugs from the CoRC back cover and insert a rubber plug at the cable exit point (2) to secure the cable.
- d.** Attach the back cover to the back of the CoRC (3).

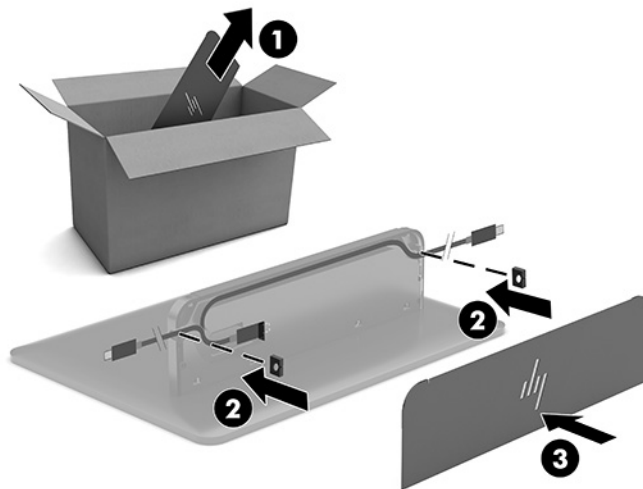

6. To connect the HDMI video input cable to the Video Ingest Module, insert the security strip (1) into the slot above the HDMI port, attach the security strip clamp (2) to the HDMI cable end, and then insert the HDMI cable end into the HDMI port on the module (3) so that the security strap is fastened by the security clip on the cable end.

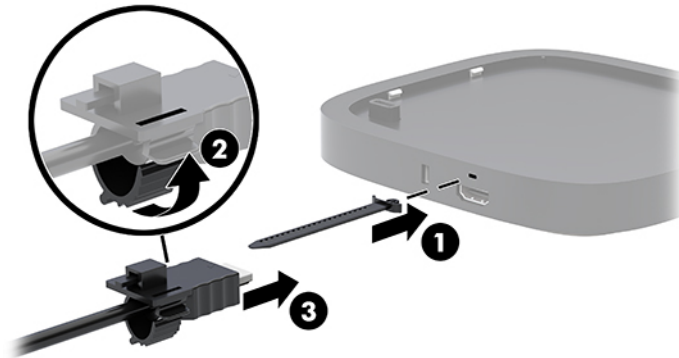

7. If the Wireless Display Module is installed, perform the following steps to install the wireless receiver:



NOTE: The receiver must face the front of the Wireless Display Module. For the best performance, be sure that the line of sight between the receiver and the Wireless Display Module is unobstructed.

- a. Connect a monitor power cord to an AC outlet (1).
- b. Use the included adhesive strip to secure the receiver in place (2). Make sure the portion of the receiver with the sync button and light is not hidden behind the monitor so that there is a clear line of sight between the Wireless Display Module and receiver.

- c. Connect the receiver to the HDMI port and a powered USB port on the monitor (3) using the HDMI cable and USB Micro-B cable included with the Wireless Display Module and receiver.

 **NOTE:** For wireless functionality, the monitor USB port that connects the receiver must provide power at all times. Be sure that the monitor settings allow the USB port to provide power when the monitor is in the sleep state.

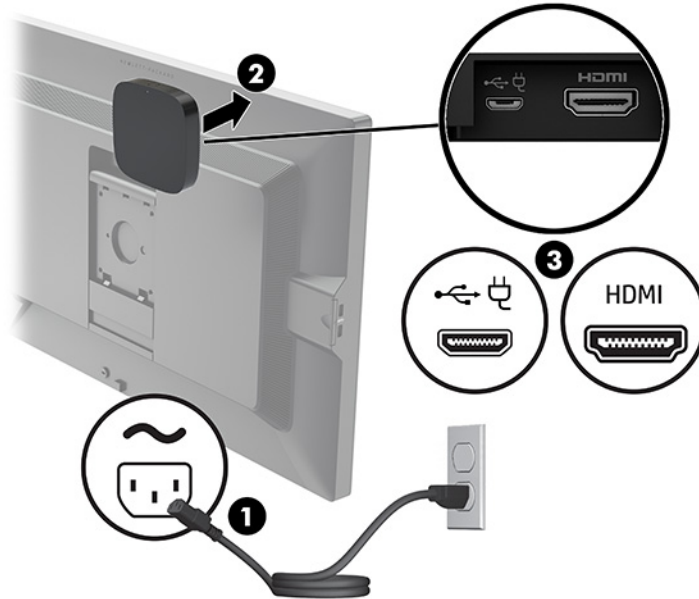

Alternatively, use the two included screws to mount the receiver VESA plate (1) onto a wall or table, and then press the receiver firmly onto the plate (2) until it clicks into place.



To remove the receiver from the VESA plate, slide the release button on the VESA plate. The receiver will pop up, allowing it to be pulled away from the VESA plate.

Make sure that the front of the receiver is facing the front of the Wireless Display Module and that the line of sight between the receiver and the Wireless Display Module is unobstructed. The wireless feature will not work if the antennas are not facing each other or if there is something blocking their line of sight. The receiver should also be no more than 8 meters (26.6 feet) from the Wireless Display Module and within a 90-degree angle.

 **NOTE:** The front of the receiver with the antenna that needs to be facing the Wireless Display Module can be identified by the sync light on the receiver. See [Wireless receiver on page 5](#) to locate the sync light on the receiver.

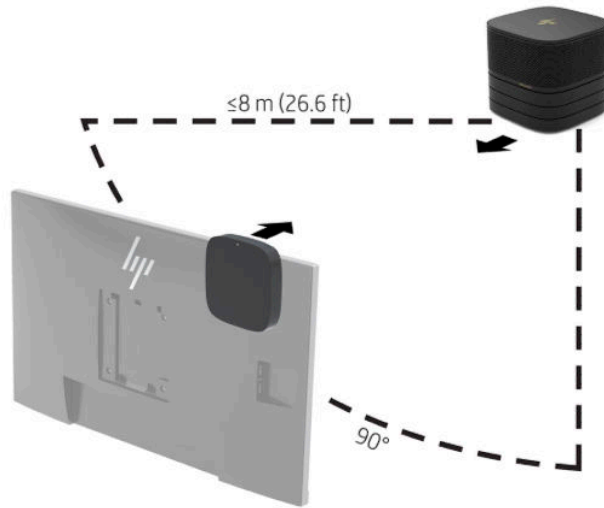

 **NOTE:** The Wireless Display Module and receiver are paired at the factory. When the system is turned on, the lights on the module and receiver are solid. If they are not solid, press the sync button on both the module and receiver. The lights will flash slowly while the module and receiver search for each other, then blink faster when the module and receiver recognize each other, and then become solid when the module and receiver establish a connection. If the module and receiver do not connect, check to be sure that the line of sight between the module and receiver is unobstructed. The lights are off when the system is turned off or in the sleep state.

8. To connect a monitor without the Wireless Display Module, perform the following steps:
 - a. Connect a monitor power cord to an AC outlet (1).

- b. Connect the monitor to an HDMI or DisplayPort connector (2) on the Cable and Port Cover.

 **NOTE:** If dual HDMI ports are required, use an active DisplayPort-to-HDMI adapter to add the second HDMI port.

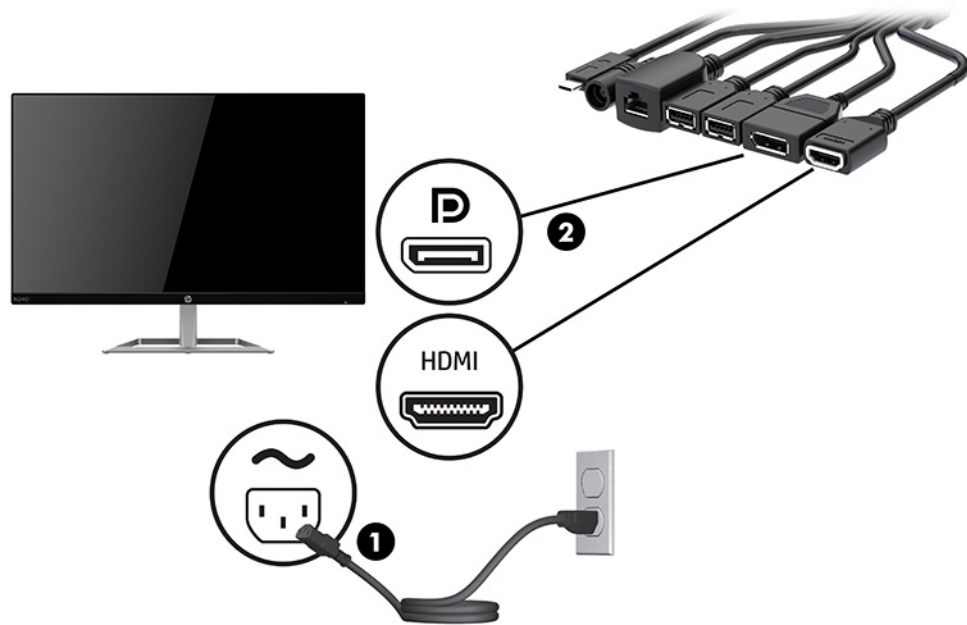

9. Connect an optional USB camera to a USB Type-A port on the Cable and Port Cover.
10. Connect a local area network (LAN) cable to an RJ-45 (network) jack on the Cable and Port Cover.

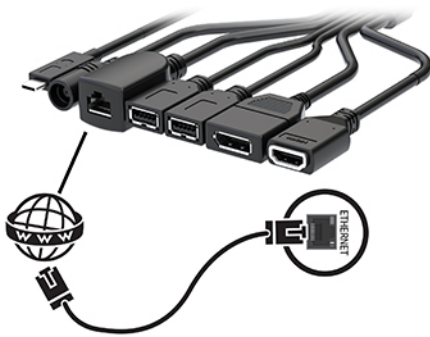

11. Connect the AC power cord to the AC adapter (1) and the other end to an AC outlet (2).

12. Connect the AC adapter to the power connector on the Cable and Port Cover (3).

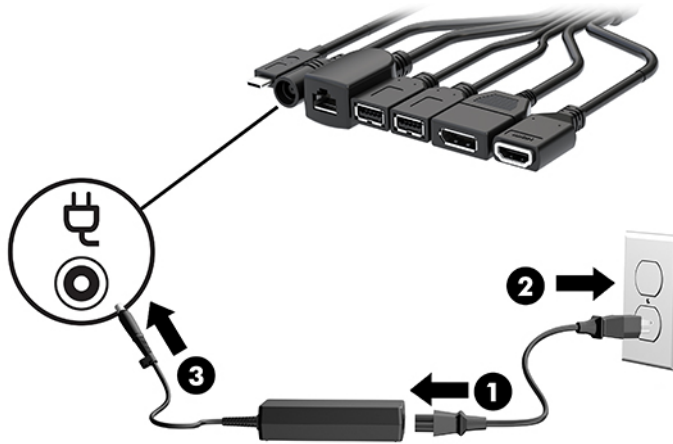

13. Press the power button.



14. Follow the Microsoft Teams Rooms instructions to install the conferencing software.

Intel Unite solution

The image below shows the Intel Unite solution wiring diagram.

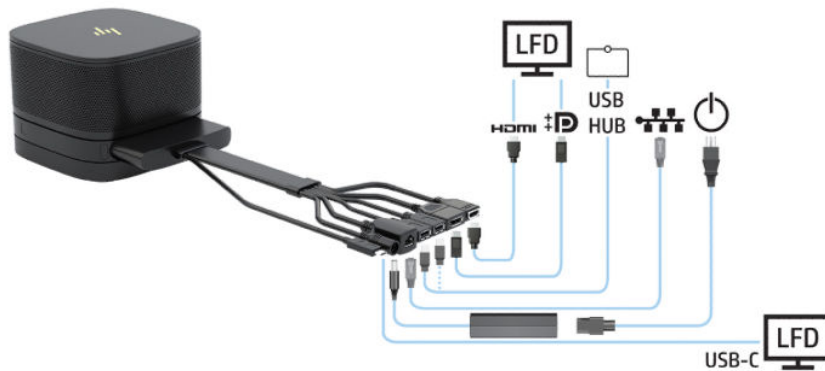

TIP: When routing cables under a table or other surface, use cable guides to minimize stress on the cables.

1. Connect the desired modules.
2. Place the product in a central location.

Be sure that nothing is placed on top of or next to the product that could block speakers and microphones.

3. Connect the Cable and Port Cover:
 - a. Pull the port cover (1) down to expose the cable connectors.
 - b. Pull the first and last connectors (2) back and then out to each side.

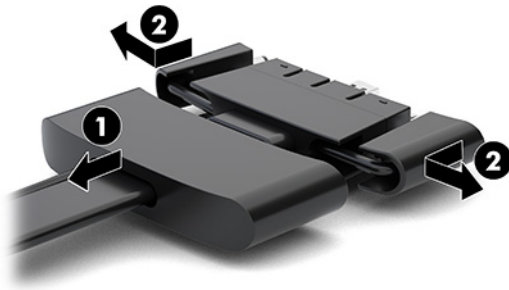

- c. Beginning with the HDMI connector and finishing with the NIC connector, plug all middle connectors (1) into the rear ports on the base module.
- d. Connect the first connector (2) and last connector (3).
- e. Push the port cover (4) back over the cable connectors to protect and secure the connectors.



4. If the Wireless Display Module is installed, perform the following steps to install the wireless receiver:

NOTE: The receiver must face the front of the Wireless Display Module. For the best performance, be sure that the line of sight between the receiver and the Wireless Display Module is unobstructed.

- a. Connect a monitor power cord to an AC outlet (1).
- b. Use the included adhesive strip to secure the receiver in place (2). Make sure the portion of the receiver with the sync button and light is not hidden behind the monitor so that there is a clear line of sight between the Wireless Display Module and receiver.
- c. Connect the receiver to the HDMI port and a powered USB port on the monitor (3) using the HDMI cable and USB Micro-B cable included with the Wireless Display Module and receiver.

 **NOTE:** For wireless functionality, the monitor USB port that connects the receiver must provide power at all times. Be sure that the monitor settings allow the USB port to provide power when the monitor is in the sleep state.

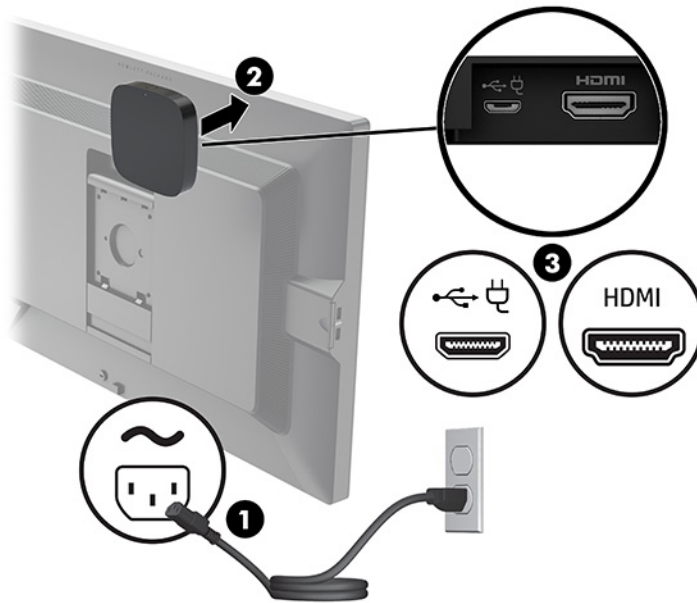

Alternatively, use the two included screws to mount the receiver VESA plate (1) onto a wall or table, and then press the receiver firmly onto the plate (2) until it clicks into place.



To remove the receiver from the VESA plate, slide the release button on the VESA plate. The receiver will pop up, allowing it to be pulled away from the VESA plate.

Make sure that the front of the receiver is facing the front of the Wireless Display Module and that the line of sight between the receiver and the Wireless Display Module is unobstructed. The wireless feature will not work if the antennas are not facing each other or if there is something blocking their line of sight. The receiver should also be no more than 8 meters (26.6 feet) from the Wireless Display Module and within a 90-degree angle.

 **NOTE:** The front of the receiver with the antenna that needs to be facing the Wireless Display Module can be identified by the sync light on the receiver. See [Wireless receiver on page 5](#) to locate the sync light on the receiver.

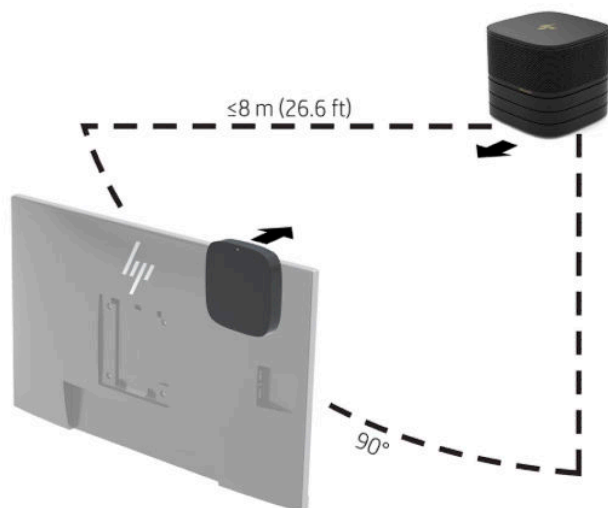

 **NOTE:** The Wireless Display Module and receiver are paired at the factory. When the system is turned on, the lights on the module and receiver are solid. If they are not solid, press the sync button on both the module and receiver. The lights will flash slowly while the module and receiver search for each other, then blink faster when the module and receiver recognize each other, and then become solid when the module and receiver establish a connection. If the module and receiver do not connect, check to be sure that the line of sight between the module and receiver is unobstructed. The lights are off when the system is turned off or in the sleep state.

5. To connect a monitor without the Wireless Display Module, perform the following steps:
 - a. Connect a monitor power cord to an AC outlet (1). You may instead connect the monitor to a powered USB Type-C port (2) on the Cable and Port Cover.

- b. Connect the monitor to an HDMI or DisplayPort connector (3) on the Cable and Port Cover. The USB Type-C port (2) on the Cable and Port Cover can also be used to connect the monitor.

 **NOTE:** If dual HDMI ports are required, use an active DisplayPort-to-HDMI adapter to add the second HDMI port.

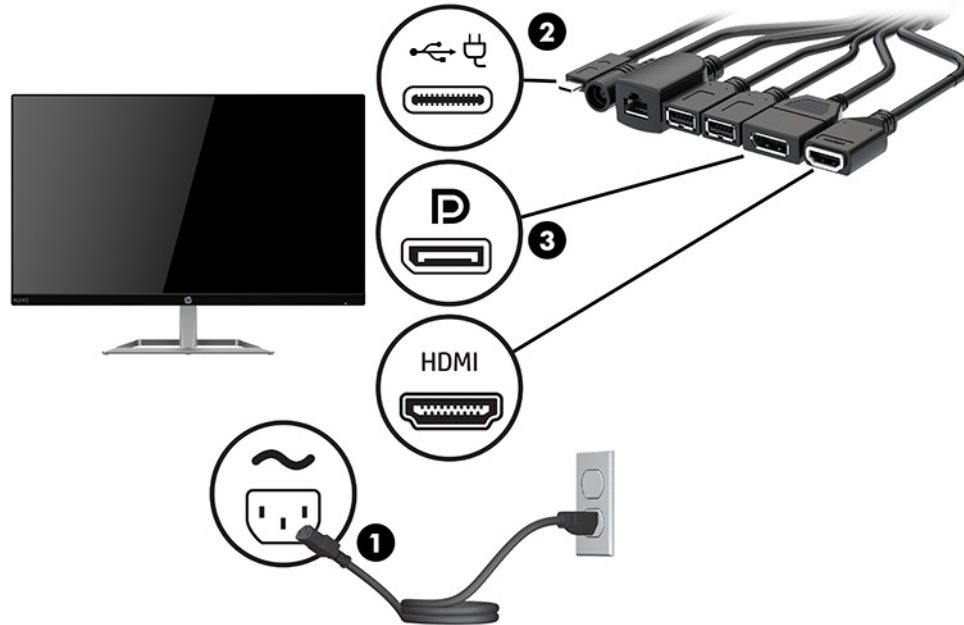

6. Connect an optional USB camera to a USB Type-A port on the Cable and Port Cover.
7. Connect a local area network (LAN) to an RJ-45 (network) jack on the Cable and Port Cover.

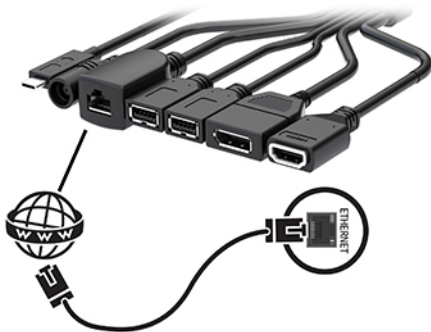

8. Connect the AC power cord to the AC adapter (1) and the other end to an AC outlet (2).

9. Connect the AC adapter to the power connector on the Cable and Port Cover (3).

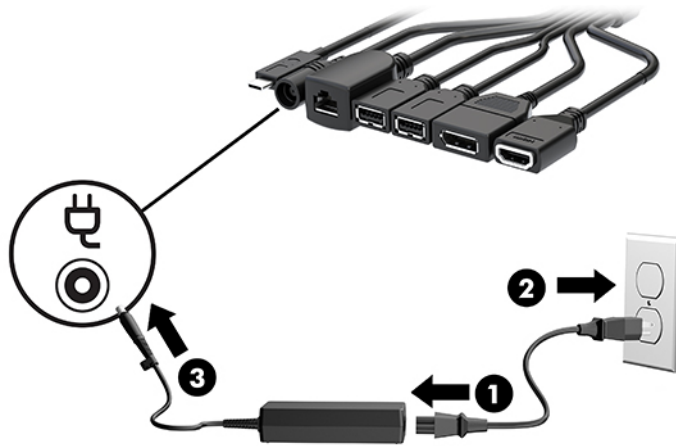

10. Press the power button.



11. Follow the Intel Unite solution instructions to install the conferencing software.

3 Hardware upgrades

Serviceability features

The computer includes features that make it easy to upgrade and service.

Warnings and cautions

Before performing upgrades, be sure to carefully read all of the applicable instructions, cautions, and warnings in this guide.

 **WARNING!** To reduce the risk of personal injury from electric shock, hot surfaces, or fire:

Disconnect the AC power cord from the AC outlet before removing the enclosure. Energized and moving parts are inside.

Allow the internal system components to cool before you touch them.

Replace and secure the enclosure before restoring power to the equipment.

Do not connect telecommunications or telephone connectors to the network interface controller (NIC) receptacles.

Do not disable the AC power cord grounding plug. The grounding plug is an important safety feature.

Plug the AC power cord into a grounded (earthed) AC outlet that is easily accessible at all times.

To reduce the risk of serious injury, read the *Safety & Comfort Guide*. It describes proper workstation setup, and proper posture, health, and work habits for computer users. The *Safety & Comfort Guide* also provides important electrical and mechanical safety information. The *Safety & Comfort Guide* is available on the Web at <http://www.hp.com/ergo>.

 **IMPORTANT:** Static electricity can damage the electrical components of the computer or optional equipment. Before beginning these procedures, ensure that you are discharged of static electricity by briefly touching a grounded metal object. See [Electrostatic discharge on page 35](#) for more information.

When the computer is plugged into an AC power source, voltage is always applied to the system board. You must disconnect the AC power cord from the power source before opening the computer to prevent damage to internal components.

Removing and replacing the access panel

Removing the access panel

The access panel must be removed to access the solid-state drive (SSD) and system memory modules.

1. Remove the base module from any additional modules.

For instructions, see [Removing modules on page 10](#).

2. Place the product upside down on a flat surface covered with a soft cloth to protect the product from scratches or other damage.
3. Loosen the four captive screws securing the access panel, and lift the panel off the base module.

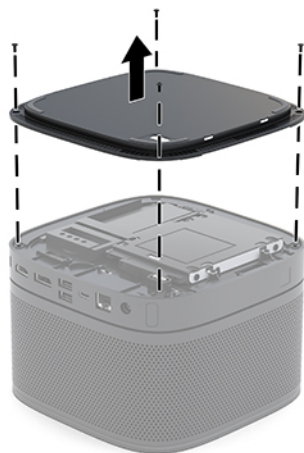

Replacing the access panel

1. Place the product upside down on a flat surface covered with a soft cloth.
2. Align the access panel with the base module so that the module connection port is clearly visible through the opening in the access panel.
3. Tighten the four captive screws to secure the access panel to the base module.

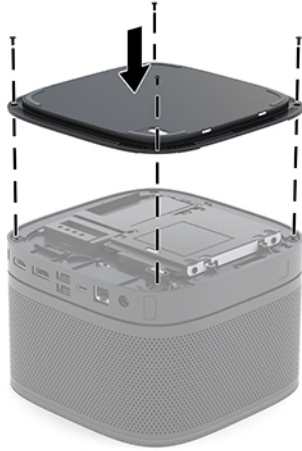

4. Reconnect any additional modules.

For instructions, see [Connecting or removing modules on page 7](#).

Locating internal components

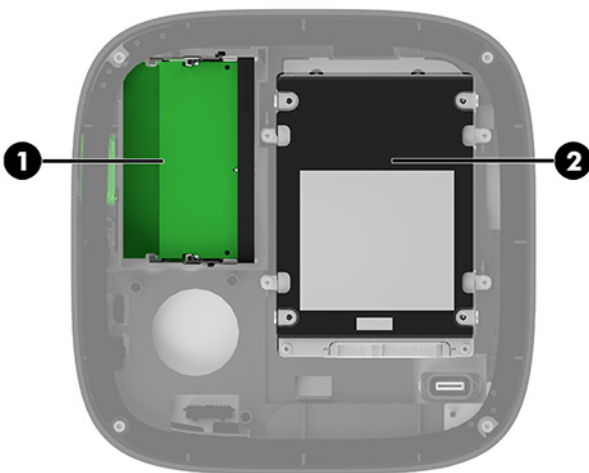

Item	Component	Item	Component
1	System memory modules	2	SSD

Upgrading system memory

The memory module slots on the system board can be populated with up to two industry-standard memory modules. At least one small outline, dual inline memory module (SODIMM) is preinstalled. To achieve the maximum memory support, you can populate the system board with up to 32 GB (16 GB x 2) of memory.



NOTE: Dual channel memory is recommended for Microsoft Teams Rooms for better performance.

Memory module specifications

For proper system operation, the SODIMMs must adhere to the following specifications:

- Industry-standard 288-pins
- Unbuffered non-ECC PC4-17000 DDR4-2133 MHz-compliant
- 1.2 volt DDR4-SDRAM SODIMMs
- Support CAS latency 15 DDR4 2400 MHz (15-15-15 timing)
- Contain the mandatory Joint Electronic Device Engineering Council (JEDEC) specification

The product supports the following:

- 512-Mbit, 1-Gbit, and 2-Gbit non-ECC memory technologies
- Single-sided and double-sided SODIMMs
- SODIMMs constructed with x8 and x16 devices



NOTE: To avoid compatibility issues, HP recommends that you use only HP memory modules in this product. The system will not operate properly if you install unsupported DIMM memory. DIMMs constructed with x4 SDRAM are not supported.

Populating memory module slots

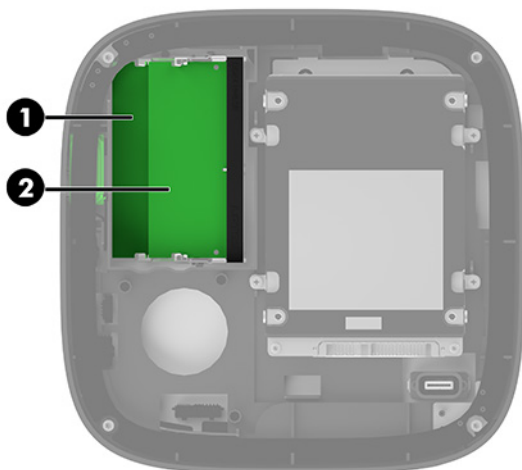

There are two memory module slots, one slot per channel. The slots are labeled DIMM1 and DIMM3. The DIMM1 slot operates in memory channel B. The DIMM3 slot operates in memory channel A.

Item	Description	System board label	Slot color
1	Memory 1 slot, Channel B	DIMM1	Black
2	Memory 3 slot, Channel A	DIMM3	Black

The system automatically operates in single-channel mode, dual-channel mode, or flex mode, depending on how the memory modules are installed.

- The system operates in single-channel mode if only one memory module slot is populated.
- The system operates in higher-performing, dual-channel mode if the capacity of the memory modules in Channel A and Channel B are equal.
- The system operates in flex mode if the capacity of the memory modules in Channel A and Channel B are not equal. In flex mode, the channel populated with the least amount of memory determines the total amount of memory that is assigned to dual-channel operation, and the remainder is assigned to single-channel operation. In flex mode, install the memory module with the larger capacity in the DIMM3 slot (Channel A).
- In any mode, the maximum operational speed is determined by the slowest memory module in the system.

Installing system memory modules

 **IMPORTANT:** You must disconnect the AC power cord and wait approximately 30 seconds for the power to drain before adding or removing memory modules. Regardless of the power-on state, voltage is always supplied to the memory modules as long as the system is plugged into an active AC outlet. Adding or removing memory modules while voltage is present may cause irreparable damage to the memory modules or system board.

The memory module slots have gold-plated metal contacts. When upgrading the memory, it is important to use memory modules with gold-plated metal contacts to prevent corrosion and/or oxidation resulting from having incompatible metals in contact with each other.

Static electricity can damage the electronic components of the system or optional cards. Before beginning these procedures, ensure that you are discharged of static electricity by briefly touching a grounded metal object. For more information, see [Electrostatic discharge on page 35](#).

When handling a memory module, be careful not to touch any of the contacts. Doing so may damage the module.

1. Remove the access panel.

For instructions, see [Removing the access panel on page 27](#).

2. To remove a memory module, press outward on the two latches on each side of the memory module (1), and then pull the memory module out of the slot (2).



3. Insert the new memory module into the slot at approximately a 30° angle (1), and then press the memory module (2) down so that the latches lock it in place.



 **NOTE:** A memory module can be installed in only one way. Match the notch on the module with the tab on the memory module slot.

4. Replace the access panel.

For instructions, see [Replacing the access panel on page 28](#).

The system automatically recognizes the additional memory when you turn on the system.

Removing and replacing a SATA SSD

 **NOTE:** Back up the SSD before you remove it so that you can transfer the data to the new SSD.

To add an SSD instead of replacing one, purchase a 4-screw after-market option kit to obtain the screws required to mount the drive.

1. Remove the access panel.
For instructions, see [Removing the access panel on page 27](#).
2. Remove the 4 screws (1) attaching the SSD cage to the system board and lift the cage (2) out of the chassis.
3. Pull the tab (3) to disconnect the SSD power-and-data cable from the SSD.

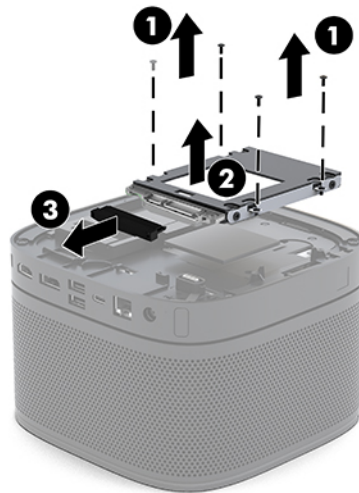

4. Remove the screws (1) securing the SSD in the cage and lift the SSD (2) out of the cage.

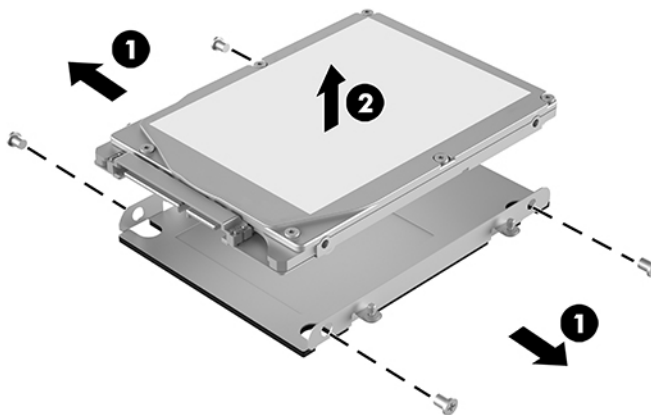

5. Position the new SSD over the drive cage with the SSD connectors at the end with the thermal patch and the circuit board side facing the closed side of the drive cage.

6. Set the new SSD (1) into the cage. Be sure that the label side of the SSD is visible.
7. Fasten the four screws (2) to secure the SSD in the cage.

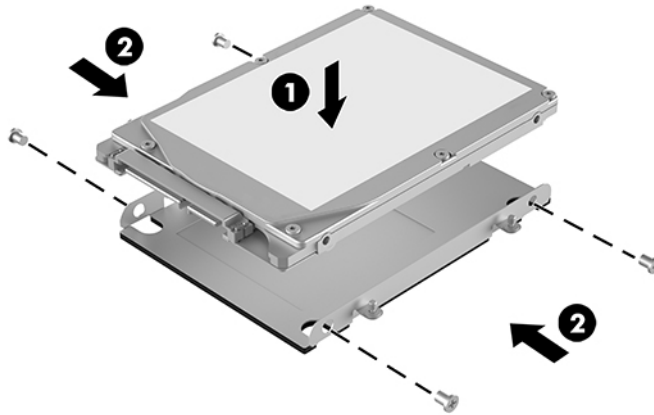

8. Connect the power-and-data cable (1) to the SSD.
9. Set the drive cage (2) in the chassis. Be sure that the SSD connectors are facing the back of the chassis.
10. Align the drive cage tabs with the screw posts in the chassis and fasten the four screws (3) to secure the SSD.

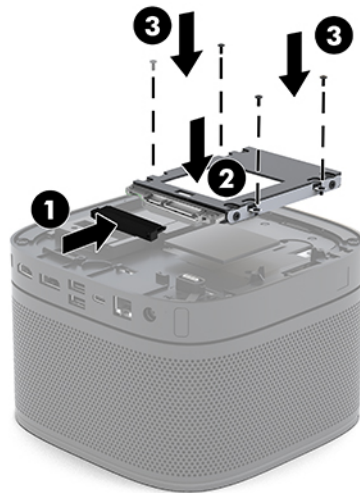

11. Replace the access panel.

For instructions, see [Replacing the access panel on page 28](#).

A Electrostatic discharge

A discharge of static electricity from a finger or other conductor may damage system boards or other static-sensitive devices. This type of damage may reduce the life expectancy of the device.

Preventing electrostatic damage

To prevent electrostatic damage, observe the following precautions:

- Avoid hand contact by transporting and storing products in static-safe containers.
- Keep electrostatic-sensitive parts in their containers until they arrive at static-free workstations.
- Place parts on a grounded surface before removing them from their containers.
- Avoid touching pins, leads, or circuitry.
- Always be properly grounded when touching a static-sensitive component or assembly.

Grounding methods

Use one or more of the following methods when handling or installing electrostatic-sensitive parts:

- Use a wrist strap connected by a ground cord to a grounded workstation or computer chassis. Wrist straps are flexible straps with a minimum of 1 megohm +/- 10 percent resistance in the ground cords. To provide proper ground, wear the strap snug against the skin.
- Use heelstraps, toestraps, or bootstraps at standing workstations. Wear the straps on both feet when standing on conductive floors or dissipating floor mats.
- Use conductive field service tools.
- Use a portable field service kit with a folding static-dissipating work mat.

If you do not have any of the suggested equipment for proper grounding, contact an HP authorized dealer, reseller, or service provider.



NOTE: For more information on static electricity, contact an HP authorized dealer, reseller, or service provider.

B Computer operating guidelines, routine care and shipping preparation

Computer operating guidelines and routine care

Follow these guidelines to properly set up and care for the computer and monitor:

- Keep the computer away from excessive moisture, direct sunlight, and extremes of heat and cold.
- Operate the computer on a sturdy, level surface. Leave a 10.2 cm (4 in) clearance on all vented sides of the computer and above the monitor to permit the required airflow.
- Never restrict the airflow into the computer by blocking any vents or air intakes. Do not place the keyboard, with the keyboard feet down, directly against the front of the desktop unit as this also restricts airflow.
- Never operate the computer with the access panel or any of the expansion card slot covers removed.
- Do not stack computers on top of each other or set anything on top of the computer.
- Do not place computers so near each other that they are subject to each other's recirculated or preheated air.
- If the computer is to be operated within a separate enclosure, intake and exhaust ventilation must be provided on the enclosure, and the same operating guidelines listed above will still apply.
- Keep liquids away from the computer and keyboard. Do not allow liquids to get on top of the computer.
- Never cover the ventilation slots on the monitor with any type of material.
- Install or enable power management functions of the operating system or other software, including sleep states.
- Turn off the computer before you do either of the following:
 - Wipe the exterior of the computer with a soft, damp cloth as needed. Using cleaning products may discolor or damage the finish.
 - Occasionally clean the air vents on all vented sides of the computer. Lint, dust, and other foreign matter can block the vents and limit the airflow.

Shipping preparation

Follow these suggestions when preparing to ship the computer:

1. Back up the SSD files to an external storage device. Be sure that the backup media is not exposed to electrical or magnetic impulses while stored or in transit.



NOTE: The SSD locks automatically when the system power is turned off.

2. Remove and store all removable media.
3. Turn off the computer and external devices.
4. Disconnect the AC power cord from the AC outlet and then from the computer.
5. Disconnect the system components and external devices from their power sources and then from the computer.



NOTE: Ensure that all boards are seated properly and secured in the board slots before shipping the computer.

6. Pack the system components and external devices in their original packing boxes or similar packaging, with sufficient packing material to protect them.

C Accessibility

Accessibility

HP is working to weave diversity, inclusion and work/life into the fabric of our company, so it is reflected in everything we do. Here are some examples of how we are putting differences to work to create an inclusive environment focused on connecting people to the power of technology throughout the world.

Finding the technology tools you need

Technology can unleash your human potential. Assistive technology removes barriers and helps you create independence at home, at work, and in the community. Assistive technology helps increase, maintain, and improve the functional capabilities of electronic and information technology. For more information, see [Finding the best assistive technology on page 39](#).

Our commitment

HP is committed to providing products and services that are accessible for people with disabilities. This commitment supports our company's diversity objectives and helps us ensure that the benefits of technology are available to all.

Our accessibility goal is to design, produce, and market products and services that can be effectively used by everyone, including people with disabilities, either on a stand-alone basis or with appropriate assistive devices.

To achieve our goal, this Accessibility Policy establishes seven key objectives to guide our actions as a company. All HP managers and employees are expected to support these objectives and their implementation in accordance with their roles and responsibilities:

- Raise the level of awareness of accessibility issues within our company, and provide our employees with the training they need to design, produce, market, and deliver accessible products and services.
- Develop accessibility guidelines for products and services, and hold product development groups accountable for implementing these guidelines where competitively, technically, and economically feasible.
- Involve people with disabilities in the development of accessibility guidelines, and in the design and testing of products and services.
- Document accessibility features and make information about our products and services publicly available in an accessible form.
- Establish relationships with leading assistive technology and solution providers.

- Support internal and external research and development that will improve assistive technology relevant to our products and services.
- Support and contribute to industry standards and guidelines for accessibility.

International Association of Accessibility Professionals (IAAP)

IAAP is a not-for-profit association focused on advancing the accessibility profession through networking, education, and certification. The objective is to help accessibility professionals develop and advance their careers and to better enable organizations to integrate accessibility into their products and infrastructure.

HP is a founding member, and we joined to participate with other organizations to advance the field of accessibility. This commitment supports our company's accessibility goal of designing, producing, and marketing products and services that can be effectively used by people with disabilities.

IAAP will make our profession strong by globally connecting individuals, students, and organizations to learn from one another. If you are interested in learning more, go to <http://www.accessibilityassociation.org> to join the online community, sign up for newsletters, and learn about membership options.

Finding the best assistive technology

Everyone, including people with disabilities or age-related limitations, should be able to communicate, express themselves, and connect with the world using technology. HP is committed to increasing accessibility awareness within HP and with our customers and partners. Whether it's large fonts that are easy on the eyes, voice recognition that lets you give your hands a rest, or any other assistive technology to help with your specific situation—a variety of assistive technologies make HP products easier to use. How do you choose?

Assessing your needs

Technology can unleash your potential. Assistive technology removes barriers and helps you create independence at home, at work, and in the community. Assistive technology (AT) helps increase, maintain, and improve the functional capabilities of electronic and information technology.

You may choose from many AT products. Your AT assessment should allow you to evaluate several products, answer your questions, and facilitate your selection of the best solution for your situation. You will find that professionals qualified to do AT assessments come from many fields, including those licensed or certified in physical therapy, occupational therapy, speech/language pathology, and other areas of expertise. Others, while not certified or licensed, may also provide evaluation information. You will want to ask about the individual's experience, expertise, and fees to determine if they are appropriate for your needs.

Accessibility for HP products

The following links provide information on accessibility features and assistive technology, if applicable, included in various HP products. These resources will help you select the specific assistive technology features and product(s) most appropriate for your situation.

- [HP Elite x3—Accessibility Options \(Windows 10 Mobile\)](#)
- [HP PCs—Windows 7 Accessibility Options](#)
- [HP PCs—Windows 8 Accessibility Options](#)
- [HP PC's—Windows 10 Accessibility Options](#)
- [HP Slate 7 Tablets—Enabling Accessibility Features on Your HP Tablet \(Android 4.1/Jelly Bean\)](#)
- [HP SlateBook PCs—Enabling Accessibility Features \(Android 4.3, 4.2/Jelly Bean\)](#)

- [HP Chromebook PCs—Enabling Accessibility Features on Your HP Chromebook or Chromebox \(Chrome OS\)](#)
- [HP Shopping—peripherals for HP products](#)

If you need additional support with the accessibility features on your HP product, see [Contacting support on page 45](#).

Additional links to external partners and suppliers that may provide additional assistance:

- [Microsoft Accessibility information \(Windows 7, Windows 8, Windows 10, Microsoft Office\)](#)
- [Google Products accessibility information \(Android, Chrome, Google Apps\)](#)
- [Assistive Technologies sorted by impairment type](#)
- [Assistive Technologies sorted by product type](#)
- [Assistive Technology vendors with product descriptions](#)
- [Assistive Technology Industry Association \(ATIA\)](#)

Standards and legislation

Standards

Section 508 of the Federal Acquisition Regulation (FAR) standards was created by the US Access Board to address access to information and communication technology (ICT) for people with physical, sensory, or cognitive disabilities. The standards contain technical criteria specific to various types of technologies, as well as performance-based requirements which focus on functional capabilities of covered products. Specific criteria cover software applications and operating systems, web-based information and applications, computers, telecommunications products, video and multi-media, and self-contained closed products.

Mandate 376 – EN 301 549

The EN 301 549 standard was created by the European Union within Mandate 376 as the basis for an online toolkit for public procurement of ICT products. The standard specifies the functional accessibility requirements applicable to ICT products and services, together with a description of the test procedures and evaluation methodology for each accessibility requirement.

Web Content Accessibility Guidelines (WCAG)

Web Content Accessibility Guidelines (WCAG) from the W3C's Web Accessibility Initiative (WAI) helps web designers and developers create sites that better meet the needs of people with disabilities or age-related limitations. WCAG advances accessibility across the full range of web content (text, images, audio, and video) and web applications. WCAG can be precisely tested, is easy to understand and use, and allows web developers flexibility for innovation. WCAG 2.0 has also been approved as [ISO/IEC 40500:2012](#).

WCAG specifically addresses barriers to accessing the web experienced by people with visual, auditory, physical, cognitive, and neurological disabilities, and by older web users with accessibility needs. WCAG 2.0 provides characteristics of accessible content:

- **Perceivable** (for instance, by addressing text alternatives for images, captions for audio, adaptability of presentation, and color contrast)
- **Operable** (by addressing keyboard access, color contrast, timing of input, seizure avoidance, and navigability)
- **Understandable** (by addressing readability, predictability, and input assistance)
- **Robust** (for instance, by addressing compatibility with assistive technologies)

Legislation and regulations

Accessibility of IT and information has become an area of increasing legislative importance. This section provides links to information on key legislation, regulations, and standards.

- [United States](#)
- [Canada](#)
- [Europe](#)
- [United Kingdom](#)
- [Australia](#)
- [Worldwide](#)

United States

Section 508 of the Rehabilitation Act specifies that agencies must identify which standards apply to the procurement of ICT, perform market research to determine the availability of accessible products and services, and document the results of their market research. The following resources provide assistance in meeting Section 508 requirements:

- www.section508.gov
- [Buy Accessible](#)

The U.S. Access Board is currently updating the Section 508 standards. This effort will address new technologies and other areas where the standards need to be modified. For more information, go to [Section 508 Refresh](#).

Section 255 of the Telecommunications Act requires telecommunications products and services to be accessible to people with disabilities. FCC rules cover all hardware and software telephone network equipment and telecommunications equipment used in the home or office. Such equipment includes telephones, wireless handsets, fax machines, answering machines, and pagers. FCC rules also cover basic and special telecommunications services, including regular telephone calls, call waiting, speed dialing, call forwarding, computer-provided directory assistance, call monitoring, caller identification, call tracing, and repeat dialing, as well as voice mail and interactive voice response systems that provide callers with menus of choices. For more information, go to [Federal Communication Commission Section 255 information](#).

21st Century Communications and Video Accessibility Act (CVAA)

The CVAA updates federal communications law to increase the access of persons with disabilities to modern communications, updating accessibility laws enacted in the 1980s and 1990s to include new digital, broadband, and mobile innovations. Regulations are enforced by the FCC and documented as 47 CFR Part 14 and Part 79.

- [FCC Guide on the CVAA](#)

Other U.S. legislation and initiatives

- [Americans with Disabilities Act \(ADA\), Telecommunications Act, the Rehabilitation Act and others](#)

Canada

The Accessibility for Ontarians with Disabilities Act was established to develop and implement accessibility standards to make goods, services, and facilities accessible to Ontarians with disabilities and to provide for the involvement of persons with disabilities in the development of the accessibility standards. The first standard of the AODA is the customer service standard; however, standards for transportation, employment, and information and communication are also being developed. The AODA applies to the Government of Ontario, the Legislative Assembly, every designated public sector organization, and to every other person or organization that provides goods, services, or facilities to the public or other third parties and that has at least one employee in Ontario; and accessibility measures must be implemented on or before January 1, 2025. For more information, go to [Accessibility for Ontarians with Disability Act \(AODA\)](#).

Europe

EU Mandate 376 ETSI Technical Report ETSI DTR 102 612: "Human Factors (HF); European accessibility requirements for public procurement of products and services in the ICT domain (European Commission Mandate M 376, Phase 1)" has been released.

Background: The three European Standardization Organizations have set up two parallel project teams to carry out the work specified in the European Commission "Mandate 376 to CEN, CENELEC and ETSI, in Support of Accessibility Requirements for Public Procurement of Products and Services in the ICT Domain."

ETSI TC Human Factors Specialist Task Force 333 has developed ETSI DTR 102 612. Further details about the work performed by STF333 (e.g., Terms of Reference, specification of the detailed work tasks, time plan for the work, previous drafts, listing of comments received and means to contact the task force) can be found at the [Special Task Force 333](#).

The parts relating to the assessment of suitable testing and conformity schemes were carried out by a parallel project, detailed in CEN BT/WG185/PT. For further information, go to the CEN project team website. The two projects are closely coordinated.

- [CEN project team](#)
- [European Commission mandate for e-accessibility \(PDF 46KB\)](#)

United Kingdom

The Disability Discrimination Act of 1995 (DDA) was enacted to ensure that websites are accessible to blind and disabled users in the United Kingdom.

- [W3C UK Policies](#)

Australia

The Australian government has announced their plan to implement [Web Content Accessibility Guidelines 2.0](#).

All Australian government websites will require Level A compliance by 2012, and Double A by 2015. The new standard replaces WCAG 1.0, which was introduced as a mandated requirement for agencies in 2000.

Worldwide

- [JTC1 Special Working Group on Accessibility \(SWG-A\)](#)
- [G3ict: The Global Initiative for Inclusive ICT](#)
- [Italian accessibility legislation](#)
- [W3C Web Accessibility Initiative \(WAI\)](#)

Useful accessibility resources and links

The following organizations may be good resources for information about disabilities and age-related limitations.



NOTE: This is not an exhaustive list. These organizations are provided for informational purposes only. HP assumes no responsibility for information or contacts you may encounter on the Internet. Listing on this page does not imply endorsement by HP.

Organizations

- American Association of People with Disabilities (AAPD)
- The Association of Assistive Technology Act Programs (ATAP)
- Hearing Loss Association of America (HLAA)
- Information Technology Technical Assistance and Training Center (ITTATC)
- Lighthouse International
- National Association of the Deaf
- National Federation of the Blind
- Rehabilitation Engineering & Assistive Technology Society of North America (RESNA)
- Telecommunications for the Deaf and Hard of Hearing, Inc. (TDI)
- W3C Web Accessibility Initiative (WAI)

Educational institutions

- California State University, Northridge, Center on Disabilities (CSUN)
- University of Wisconsin - Madison, Trace Center
- University of Minnesota computer accommodations program

Other disability resources

- ADA (Americans with Disabilities Act) Technical Assistance Program
- Business & Disability network
- EnableMart
- European Disability Forum
- Job Accommodation Network
- Microsoft Enable
- U.S. Department of Justice - A Guide to disability rights Laws

HP links

[Our contact webform](#)

Contacting support



NOTE: Support is in English only.

- Customers who are deaf or hard of hearing that have questions about technical support or accessibility of HP products:
 - Use TRS/VRS/WebCapTel to call (877) 656-7058 Monday through Friday, 6 a.m. to 9 p.m. Mountain Time.
- Customers with other disabilities or age-related limitations who have questions about technical support or accessibility of HP products, choose one of the following options:
 - Call (888) 259-5707 Monday through Friday, 6 a.m. to 9 p.m. Mountain Time.
 - Complete the [Contact form for people with disabilities or age-related limitations](#).

Index

- A**
 - AC power 12
 - access panel
 - removing 27
 - replacing 28
 - accessibility 38
 - accessibility needs assessment 39
 - assistive technology (AT)
 - finding 39
 - purpose 38
 - AT (assistive technology)
 - finding 39
 - purpose 38
- C**
 - Cable and Port Cover 13, 20
 - capacitive touch buttons 1
 - cautions 26
 - components
 - rear 2
 - side 3
 - top 1
 - computer operating guidelines 36
 - conferencing
 - Intel Unite 20
 - Microsoft Teams Rooms 13
 - customer support, accessibility 45
- E**
 - electrostatic discharge, preventing damage 35
- F**
 - features
 - ODD Module 5
 - VESA Plate 6
 - Video Ingest Module 4
 - Wireless Display Module 4
- G**
 - grounding methods 35
- H**
 - HP Assistive Policy 38
 - HP Center of Room Control (CoRC) Module 6
- I**
 - installation guidelines 26
 - installing
 - security cable 11
 - SSD 33
 - system memory 29, 31
 - Intel Unite solution 20
 - internal components 28
 - International Association of Accessibility Professionals 39
- M**
 - memory, system
 - installing 29, 31
 - replacing 31
 - slot population 30
 - slots 29
 - specifications 29
 - Microsoft Teams Rooms conferencing 13
 - module
 - Cable and Port Cover 13, 20
 - ODD Module 5
 - order 7
 - removing 10
 - sequence 7
 - VESA Plate 6
 - Video Ingest 4
 - Wireless Display 4
 - mounting the product 11
- O**
 - ODD Module 5
 - optical disc drive 5
- P**
 - power 12
 - product ID location 3
- R**
 - rear components 2
 - removing
 - access panel 27
 - modules 10
 - SSD 33
 - replacing
 - access panel 28
 - system memory 31
 - resources, accessibility 44
- S**
 - Section 508 accessibility standards 40, 41
 - security cable, installing 11
 - serial number location 3
 - setting up Intel Unite 20
 - setting up Microsoft Teams Rooms 13
 - setup 7
 - shipping preparation 37
 - side components 3
 - specifications, system memory 29
 - SSD
 - installing 33
 - removing 33
 - standards and legislation, accessibility 40
- T**
 - top components 1

U

Unite solution 20

V

ventilation guidelines 36

VESA Plate 6

Video Ingest Module 4

W

warnings 26

Wireless Display Module 4

wireless receiver 4

wireless receiver 4